

VILTROX

AF 90/2.2 EVO E

E-Mount

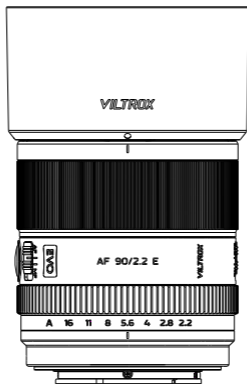

Thank you for choosing Viltrox Lens !

Before mounting the lens onto your camera, please read this manual carefully so as to understand and use all the functions of the Lens.

Shenzhen Jueying Technology Co., Ltd

TEL: +86-755-2877 9024

MAIL: info@viltrox.com

Address: No. 1207, Floor 12, Building B, Zhantao Building, Minzhi Sub-district,
Longhua District, Shenzhen

Standard: GB/T9917.2-2008

FAX: 0755-2877 4730

URL: www.viltrox.com



Function

AF 90/2.2 EVO E is an auto focus lens suitable for E-mount, with 10 elements in 8 groups, the focus distance is about 0.74m-∞, and noiseless STM focus motor can accurately control the moving position and bring accurate and smooth focusing.

- * 90mm focal length, F2.2 large aperture
- * 10 elements in 8 groups, including 2 high refractive lens and 2 ED lens
- * HD Nano multilayer coating with water-resistant and antifouling coating
- * Quiet STM focus motor, fast and accurate focusing
- * Precision hardened aluminum alloy bayonet

Identifying the Parts

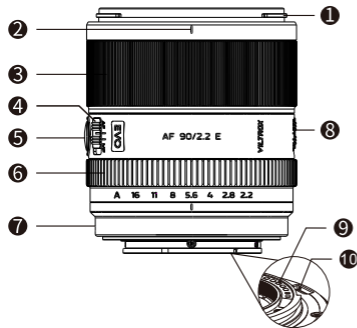

- 1 Lens Hood Position
- 2 Lens Hood Index
- 3 Focusing Ring
- 4 Focusing mode switch (MF/AF)
- 5 Custom button Fn
- 6 Aperture ring
- 7 Mounting Index
- 8 CLICK switch
- 9 Electronic Contacts
- 10 USB Type-C upgrade port

Lens Hood

Lens hood is used to reduce flare or scattering light of ghost and avoid rain, snow and dust sticking to the front of the lens.

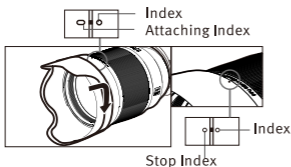

● Attaching the Lens Hood

Align the attaching index on the lens hood with the index on the lens, then insert the lens hood into the lens mount and rotate it clockwise until it clicks and now the stop index on the lens hood should match the index on the lens.

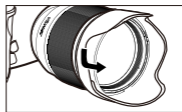

● Detaching the Lens Hood

Rotate the lens hood counterclockwise until the attaching index is aligned with the index on the lens, then remove the lens hood.

The lens hood can be attached or stored in the opposite direction.

Lens Construction Diagram

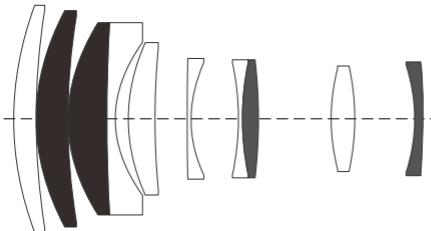

 High refractive lenses

 ED low-dispersion lenses



MTF Graph

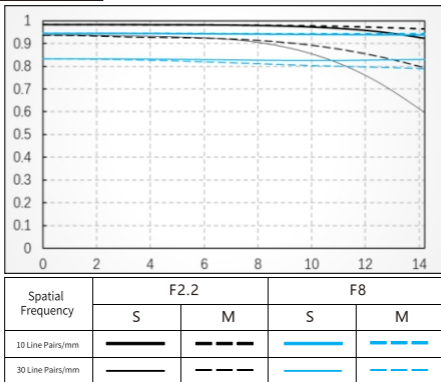

Attaching and Detaching the Lens

● To attach the lens

Align the white index on the lens barrel with the white index on the camera, then insert the lens into camera mount and rotate it clockwise until it locks.
(For further details of attaching and detaching lens, please kindly refer to the User Manual of the camera.)

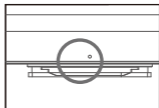

● To detach the lens

While holding down the lens release button on the camera, rotate the lens counterclockwise until it stops, then detach the lens.
Please place the back of the lens upward to avoid scratches on the lens surface and the electronic contacts.

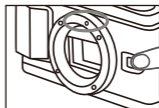

● Lens Cap

When lens is detached, please cover it with a dust cap. Align the mounting index on the dust cap with the mounting index on the lens, then rotate the cap clockwise until it stops. And rotate it counterclockwise when removing the cap.

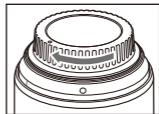

Attentions

- To take the lenses from cold environment to warm environment, condensation might occur on lenses and internal parts. To prevent condensation under this circumstance, put the lenses inside an airtight plastic bag before taking them from cold environment to warm environment. After the lenses gradually become warm, take them out for use. Please follow this step too in taking lenses from warm environment to cold environment.
- Please don't put lens in places where temperature is too high such as cars directly exposed to the sun. High temperature might cause lens failures.
- To mount lenses on cameras, you'd better hold the lenses (do this too in mounting the lenses on the tripods).

Safety Instructions

- Please don't view the sun or bright light sources through lenses or cameras, or else your eyesight will be impaired. It is especially harmful to directly watch the sun through lenses.
- Please don't take photos by pointing the lenses or cameras at the sun. The lenses will focus on light, so the cameras will fail or be caught in fire even if the sun is not within the image area, or photos are taken against light.
- No matter if lens are mounted on the cameras, please don't put the uncapped lenses in the sun, or else the lenses might converge light sources and thus cause fire.

Cleaning

- Please don't directly touch lenses with hands, or else the lenses will become dirty. Please blow dust away with lens plunger, and gently scrub the lenses with clean soft lens cleaning wipes.
- Please don't use any organic solvent such as thinner and petrol to clean lenses.

The operating manual is only for reference, and the right to interpret the manual shall be owned by us.



Product Parameters

Item	AF 90/2.2 EVO E
Camera Mount	E-Mount
Lens Elements	8/10
Aperture Control	9
Focal Length <small>(equivalent to 35mm format)</small>	f=90mm(135mm)
Viewing Angle	18.6°
Format Compatible Frames	APS-C
Aperture	F2.2-F16
Shooting Distance	0.74m-∞
Focus Mechanism	internal focusing
Focus Motor	STM+Lead screw
Focus Mode	MF, AF
Max. Magnification	0.14X
Lens Size (Diameter/Length) <small>(Diameter x length/Distance from lens mount flange the end of lens)</small>	Φ 69mmx76mm
Weight <small>(excluding lens cap and lens hood)</small>	≈320g
Filter Size	Φ58

The Company reserves the right to change the appearance, technical specifications and performance of this product at any time.