

KODAK PIXPRO AZ653

DIGITAL CAMERA

User Manual



BEFORE YOU START

Declaration of Conformity

Responsible Party: JK Imaging Ltd.

Address: JK Imaging Ltd., 14067 Stage Road, Santa Fe Springs, CA 90670 USA

Company Website: kodakpixpro.com

INDUSTRY CANADA

This device complies with Canadian RSS-247.

This device complies with Industry Canada license-exempt RSS standard (s). Operation is subject to the following two conditions: (1) this device may not cause interference and (2) this device must accept any interference, including interference that may cause undesired operation of the device.

Radiation Exposure Statement:

This product complies with the Canadian portable RF exposure limit set forth for an uncontrolled environment and is safe for intended operation as described in this manual. Additional RF exposure reduction can be achieved if the product can be kept as far as possible from the user body or set the device to lower output power if such function is available.

For Customers in Europe



This symbol [crossed-out wheel bin WEEE Annex IV] indicates separate collection of electrical waste and electronic equipment in the European countries. Please do not throw the equipment into domestic refuse. Please use the return and collection systems available in your country for proper, safe disposal of this product.



“CE” mark indicates that this product complies with the European requirements for safety, health, environment and customer protection. “CE” marked cameras are intended for sales in Europe.

Europe – EU Declaration of Conformity

This device complies with the essential requirements of the R&TTE Directive 2014/53/EU. The following test methods have been applied in order to prove presumption of conformity with the essential requirements of the R&TTE Directive 2014/53/EU:

- EN 62368-1:2014

Safety of Information Technology Equipment

- EN 50566:2017

Product standard to demonstrate compliance of radio frequency fields from handheld and body-mounted wireless communication devices used by the general public (30 MHz – 6 GHz)

- EN 62209-2:2010/A1:2019

Human exposure to radio frequency fields from handheld and body-mounted wireless communication devices — Human models, instrumentation, and procedures

Part 2: Procedure to determine the specific absorption rate (SAR) for wireless communication devices used in close proximity to the human body (frequency range of 30 MHz to 6 GHz)

- EN 300 328 V2.2.2 (2019-07)

Electromagnetic compatibility and Radio spectrum Matters (ERM); Wideband transmission systems; Data transmission equipment operating in the 2.4GHz ISM band and using wide band modulation techniques; Harmonized EN covering the essential requirements of article

- EN 301 489-1 V2.2.3 (2019-11)

Electromagnetic compatibility and Radio Spectrum Matters (ERM); Electro Magnetic Compatibility (EMC) standard for radio equipment and services; Part 1: Common technical requirements.

- EN 301 489 -17 V3.2.4 (2020-09)

Electromagnetic compatibility and Radio spectrum Matters (ERM); ElectroMagnetic Compatibility (EMC) standard for radio equipment; Part 17: Specific conditions for Broadband Data Transmission Systems

Hereby, Sintai Optical (Shenzhen) Co., Ltd, declares that this PIXPRO AZ653 is in compliance with the essential requirements and other relevant provisions of Directive 2014/53/EU.

Manufacturer: Sintai Optical (Shenzhen) Co., Ltd

Address: Qiwei Ind Sec, 1st, 2nd, 4th & 5th Bldg, Lisonglang Village, Gongming Street, Guangming New District, Shenzhen, Guangdong, China



Batteries: Please dispose of used batteries at designated collection centers.



Packaging: Please follow local regulations for the recycling of packaging.

For Customers in the U.S.A.

Federal Communication Commission Interference Statement

This device complies with Part 15 of the FCC Rules. Operation is subject to the following two conditions: (1) This device may not cause harmful interference, and (2) this device must accept any interference received, including interference that may cause undesired operation.

This equipment has been tested and found to comply with the limits for a Class B digital device, pursuant to Part 15 of the FCC Rules. These limits are designed to provide reasonable protection against harmful interference in a residential installation. This equipment generates, uses and can radiate radio frequency energy and, if not installed and used in accordance with the instructions, may cause harmful interference to radio communications. However, there is no guarantee that interference will not occur in a particular installation. If this equipment does cause harmful interference to radio or television reception, which can be determined by turning the equipment off and on, the user is encouraged to try to correct the interference by one of the following measures:

- Reorient or relocate the receiving antenna.
- Increase the separation between the equipment and receiver.
- Connect the equipment into an outlet on a circuit different from that to which the receiver is connected.
- Consult the dealer or an experienced radio / TV technician for help.

FCC Caution: Any changes or modifications not expressly approved by the party responsible for compliance could void the user's authority to operate this equipment.

This transmitter must not be co-located or operating in conjunction with any other antenna or transmitter.

Radiation Exposure Statement:

This product complies with the FCC portable RF exposure limit set forth for an uncontrolled environment and is safe for intended operation as described in this manual. Additional RF exposure reduction can be achieved if the product can be kept as far as possible from the user body or set the device to lower output power if such function is available.

About this Manual

Thank you for purchasing this KODAK PIXPRO Digital Camera. Please read this manual carefully and keep it in a safe place for future reference.

- JK Imaging Ltd. reserves all rights of this document. No part of this published manual may be reproduced, transmitted, transcribed, stored in a retrieval system or translated into any language or computer language, in any form, by any means, without the prior written permission of JK Imaging Ltd.
- All trademarks mentioned in this manual are used for identification purposes only and are properties of their respective owners and holders.
- This manual provides you with instructions on how to use your new KODAK PIXPRO Digital Camera. Every effort has been made to ensure that the contents of this manual are accurate; however JK Imaging reserves the right to make changes without notice.
- Throughout this manual, the following symbols are used to help you locate information quickly and easily:



Indicates useful information.

- The following symbols may be used throughout this manual to facilitate your understanding of how to operate the camera:
[Item properties] : The optional properties in the camera interface are indicated by the [] symbol.

SAFETY NOTES

Safety Notes for this Camera

- Do not drop the camera or allow it to hit solid objects.
- Do not attempt to disassemble or repair the camera.
- Do not use or store the camera in dusty places or on a beach to help prevent dust or sand from entering the camera, causing possible damage.
- Do not use or store the camera in a hot environment or in direct sunlight.
- Do not use or store the camera near powerful magnetic fields, such as a magnet or transformer.
- Avoid touching the lens of the camera.
- Do not expose the camera to direct sunlight for a long period of time.
- To prevent the camera from being damaged by moisture, do not use or store the camera in very humid environments, such as in rain or near bodies of water.
- If water accidentally comes in contact with the camera, turn the camera off immediately, remove the battery and the memory card and dry it completely within 24 hours.
- When you take the camera from a cold environment to a warmer environment, condensation may occur. Please wait for a reasonable period of time before you turn the camera on.
- Before you remove the battery and memory card, the camera should be turned off.
- When you clean the body of the camera, do not use abrasive, alcohol-based or organic cleansers or solvents.
- Use a professional lens cleaning cloth and appropriate cleaner to wipe and clean the lens.
- Download your photos and remove the memory card when you are going to store the camera for long periods of time.
- If this camera is not in use for a long period of time, please keep it in a dry and clean storage location.
- Our company will not pay compensation for any failure of playback including: pictures or videos damaged or unrecoverable by improper operation.

Safety Notes for Battery

- Please use a battery that is the same type as the one included.
- Please use the attached charger to charge the battery.
- If battery fluid leaks inside the camera, contact our customer service department immediately. If battery fluid leaks onto your skin, rinse your skin immediately with clean water and seek immediate medical attention.
- Disposal of used batteries should be carried out in accordance with your local (national or regional) regulations.
- To prevent the battery from being damaged, do not drop the battery or allow it to hit solid objects or to be scratched by foreign objects.
- Do not let the battery come in contact with metal objects (including coins) to avoid short circuiting, discharging, excessive heat or possible leakage.
- Do not attempt to disassemble the battery.
- Do not expose the battery to water. Always keep the battery contacts dry.
- Do not heat the battery or throw it into a fire to avoid a possible explosion.
- Do not store the battery in a hot environment or in direct sunlight.
- If the battery overheats during charging or use, stop charging or use immediately. Turn off the product, remove the battery carefully, and wait until it cools down.
- When the camera is stored for a long period of time, remove the battery and keep it in a safe, dry place that is not accessible to infants and children.
- In colder environments, the performance of the battery could be noticeably reduced.
- When you install the battery, align the battery markings according to the positive and negative markings inside the camera battery compartment. Never force the battery into the battery compartment.

Safety Notes for Memory Card

- We highly suggest buying only well-known, name brand memory cards to ensure peak performance and reliability.
- Format the memory card using the camera before you use it or insert a new one.
- Do not drop the memory card or allow it to hit solid objects to avoid damaging it.
- Do not attempt to disassemble or repair the memory card.
- Do not expose the memory card to water. Always keep it dry.
- Do not remove the memory card when the camera is turned on. Otherwise, the memory card and photo/video files could be permanently damaged.
- Do not directly edit the data on the memory card. Copy the data to your computer before you edit files.
- When the camera is stored for long periods of time, be sure to download your photos and remove the memory card. Store the memory card in a dry environment.
- Do not modify the name of the files or folders of the memory card using your computer. Modifying the file names may cause the files to not be recognized on the camera or a possible permanent error may occur.
- A photo taken with the camera will be stored in the folder that is automatically generated on the memory card. Do not store photos that are not taken using this camera in these folders as the pictures cannot be recognized during playback.
- When you insert the memory card, make sure the notch of the card matches the markings on the top of the camera card slot.



Other Safety Notes

- Do not disconnect the power or turn the camera off during the update process. Doing so may cause incorrect data to be written and the camera may not power on later.
- Do not hang the neck strap of the camera around the neck of a child.
- When using your camera on an airplane, observe the relevant rules specified by the airline and FAA regulations.
- Due to the limitations of manufacturing technology, the LCD may have a few dead or bright pixels. These pixels do not affect the quality or performance of the camera, photos or video.
- Do not expose the camera's LCD to water. In a humid environment, only wipe it with a soft, dry, cleaning cloth.
- If the LCD is damaged and the liquid crystal comes into contact with your skin, wipe your skin with a dry cloth immediately and rinse it with clean water. If liquid crystal comes into contact with your eyes, wash them with clean water at least for 15 minutes and seek immediate medical attention. If you accidentally swallow liquid crystal, rinse your mouth immediately and seek medical attention.

WARNING

- Altering, tampering or modifying any parts of the AZ653 camera are unauthorized and will void the manufacturer's warranty and "could" void Federal and/or State Compliance.

CONTENTS

BEFORE YOU START	1	Resetting Date / Time	26
SAFETY NOTES	6	MODE OVERVIEW	27
CONTENTS	10	LCD Display	27
GETTING READY	14	Overview of the Screen Icons in Shooting Mode	27
Accessories Included	14	Overview of the Screen Icons in Movie Mode	29
Installing Lens Cap and Neck Strap	15	Overview of the Screen Icons in Playback Mode	30
Part Names	16	How to Take Pictures	31
Installing Battery and Memory Card	19	Using the Mode Dial	32
Charging the Battery	21	Face Beautifier 	35
Turning Camera On and Off	23	Wireless® Mode 	36
Set your Language, Date / Time after the First Power-On	24	Scene Mode SCN	43
Set your Language, Date / Time	24	Custom Settings (CS)	49
Resetting your Language	25	BASIC OPERATION	51
		Using EVF (Electronic View Finder)	51

Using the Zoom Function.....	52
Display Setting	53
AF Area	55
Macro Mode.....	56
Self-Timer Mode	57
Flash Mode	58
WB (White Balance) Mode	60
Continuous Shot Mode	62
Exposure Compensation Functions Setting	64
EV Adjustment.....	64
ISO Adjustment.....	65
Shutter Speed Adjustment	65
Aperture Adjustment	66
Using Quick Recording	66
“i” Button Function Menu.....	67
Using the Lens Function Ring	68
Zoom / AF Mode	68







Function Ring (Smart) Mode	69
MF (Manual Focus) Mode.....	70

PLAYBACK 71

Viewing Photos and Videos	71
Thumbnail View.....	72
Using Zoom Playback (for still pictures only).....	73
Continuous Shot Group Playback ..	74
Animation Panorama Play	75
Slideshow	76
Deleting Photos and Videos.....	77

USING THE MENUS..... 78

Shooting Menu	78
Expo Metering.....	79
OIS (Optical Image Stabilization)	79

Beautifier	80	Display Mode 	93
Select Scene	80	Rotate 	93
Shoot Setting1	81	Color 	94
Image Size	82	HDR 	95
Movie Size	83	Touch-Up 	96
Quality	84	Resize 	97
MF (Manual Focus) Assist	85	Playback Settings	97
AF Assist Beam.....	86	Protect	98
Digital Zoom.....	86	Delete	98
Shoot Setting 2.....	87	DPOF (Digital Print Order Format)	99
Date Imprint	88	Trim.....	100
Quick Review.....	88	Play Slide Show	100
Continuous AF	89	General Settings.....	101
Face Detection	89	Sound Settings.....	102
Custom Settings	90	Power Saver.....	102
Function Ring (Smart).....	91	Language.....	103
Playback Menu	92	World Time	103
Menu 	92		

Date & Time	103
LCD Brightness.....	103
File Settings.....	104
Format	105
Copy to Card.....	106
File Numbering.....	106
Reset Settings	107
Version.....	107

CONNECTION SETTINGS .. 108

Connecting to a Computer.....	108
Setting the USB Mode	108
Transferring Files to your Computer	109
Supported HDMI Connections	110
Connecting HDMI-Ready TV.....	110

APPENDICES 111

Product Specifications.....	111
Prompts and Warning Messages	115
Troubleshooting	120
Memory Card Compatibility	125
Trademarks	126

GETTING READY

Accessories Included

Your camera box should contain the camera model you purchased along with the following accessories. If anything is missing or appears to be damaged, please contact your retailer first or our customer service center.

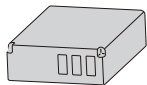

Rechargeable
Li-ion Battery

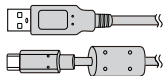

Type-C USB Cable

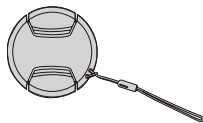

Lens Cap With Strap



Neck Strap

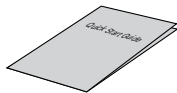

Quick Start Guide



Warranty Card



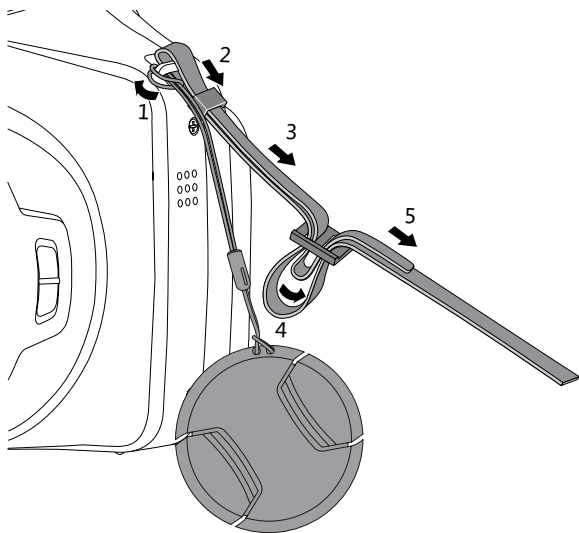

Service Card

Installing Lens Cap and Neck Strap



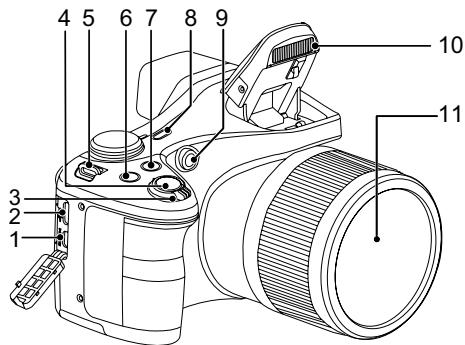





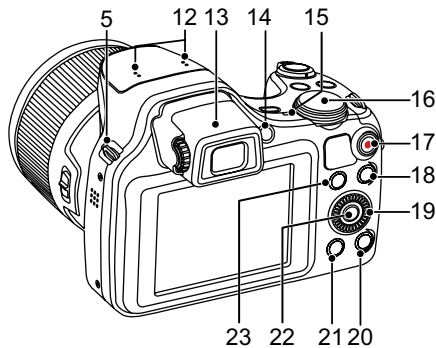









Part Names



1. HDMI Port
2. USB-C Port
3. Zoom Lever
4. Shutter Button
5. Strap Eyelet
6.  Exposure Compensation Button
7.  Continuous Shot Button
8. Power Button
9. AF Assist Beam / Self-Timer Lamp
10. Flash Lamp
11. Lens



- 12. Microphone
- 13. Electronic View Finder (EVF)
- 14.  EVF / LCD Switch Button
- 15. Indicator Lamp
- 16. Mode Dial
- 17.  Quick Switch Video Record Button
- 18.  Menu Button
- 19.  Jog Dial
- [ **AF**] AF Button / Up Button
- [  ] Delete Button / Self-Timer Button / Down Button
- [ ] Macro Button / Left Button
- [ ] Flash Button / Right Button
- 20.  Playback Button
- 21.  Display Button
- 22.  SET Button
- 23.  "i" Button



Rotating the  jog dial can be used to quickly select settings instead of using the up / down / left / right buttons.

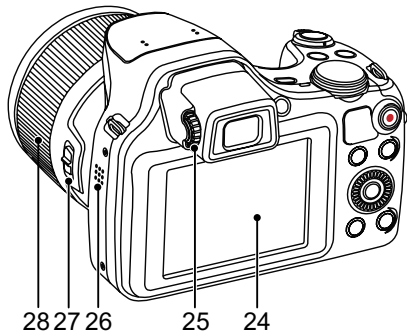

- 24. LCD
- 25. Diopter Adjustment Knob
- 26. Speaker
- 27. Lens Function Ring Lever
- 28. Lens Function Ring

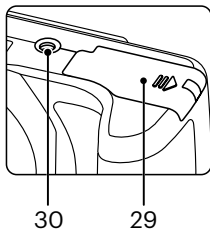

- 29. Battery Cover
- 30. 1/4" Tripod Socket

Installing Battery and Memory Card

1. Open the battery cover door.

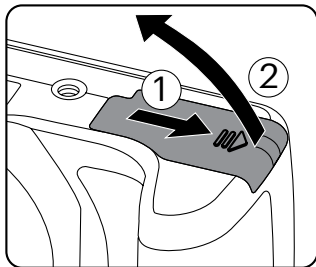

2. Insert the battery into the battery compartment corresponding to the negative and positive directions as illustrated in the picture. Push the battery down until it locks in place.

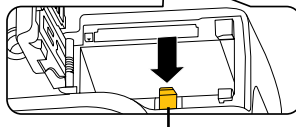
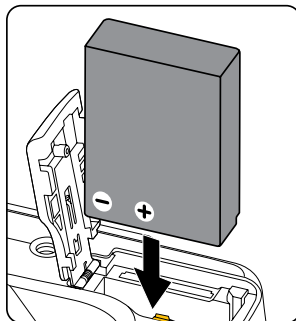

Battery Lock Knob

3. Insert the memory card into the memory card slot as shown in the diagram:

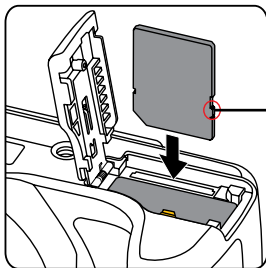

Write Protection
Toggle Switch

4. Close the battery cover door.

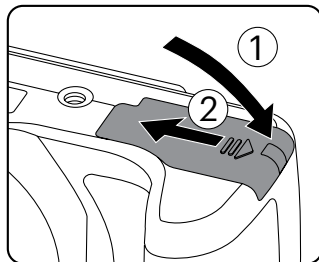

A standard SD memory card is not included in the camera packaging and needs to be purchased separately. This camera takes a standard (SD / SDHC / SDXC) memory card. We recommend using a name brand memory card that is Class 10 or higher and has a capacity of 4GB to 1.5TB. The camera is not compatible with Micro SD, Ultra, Ultra Plus, Extreme, XC, or adapters for any of these other memory cards.



To remove your memory card, open the battery cover door, gently press the memory card to eject it and remove it carefully.

Charging the Battery

Before you charge the battery, you should turn the camera off and insert the battery.

1. Connect the camera to the power charger using the supplied USB cable.
2. Insert the plug of the power charger into the power outlet to charge the battery.

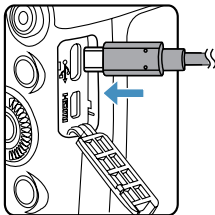

After the battery is stored for long periods of time, use the supplied power charger to charge the battery prior to use.

Indicator Lamp

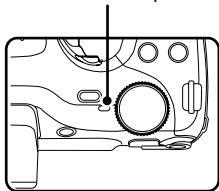

Charging indicator:

Steady orange: Charging

Steady green: Charging complete

To maximize battery life, charge the battery for at least 4 hours the first time.



Please charge the battery indoors between 0°C and 40°C (32°F and 104°F).

Turning Camera On and Off

Press the Power button to turn the camera on. To turn the camera off, press the Power button again.

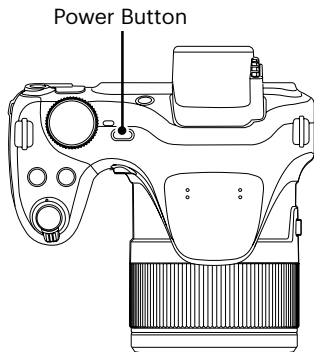

When the power is off, press and hold the playback  button to power on and enter Playback mode.

Set your Language, Date / Time





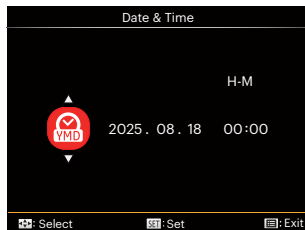

Set your Language, Date / Time after the First Power-On

1. When you turn the camera on for the first time, the language selection screen appears.
2. Press the [▲ AF] / [▼ 𠄎 𠄎] button to select your desired language.
3. After you press the (SET) button to confirm your language selection, the Date / Time settings screen will appear.
4. Press the [◀ 𠄎] / [▶ 𠄎] button to select the Date/Time to be adjusted: Time is displayed in YYYY.MM.DD / HH:MM.
5. Press the [▲ AF] / [▼ 𠄎 𠄎] button to adjust the value for the desired Date / Time.
6. Press the (SET) button to confirm the time settings and the shooting screen will appear.



Resetting your Language





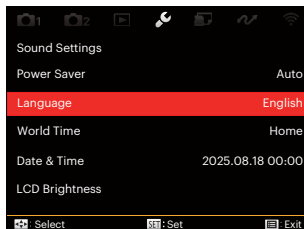

After you set your language for the first time, follow the instructions below to reset your language.

1. Press the  button, press the [▲AF] / [▼🗑️🔌] button to select  and press the  button to enter the menu.
2. Press the [◀🌱] / [▶⚡] button to select .
3. Press the [▲AF] / [▼🗑️🔌] button to select [Language] and press the  button to enter the menu.
4. Press the [▲AF] / [▼🗑️🔌] button to select your desired language and press the  button to confirm.
5. Press the  button and the shooting screen will appear.



Resetting Date / Time

After you set your Date / Time for the first time, follow the instructions below to reset date and time.

1. Press the  button, press the [▲ AF] / [▼ ❸ ❹] button to select , and press the  button to enter the menu.
2. Press the [◀ ❶] / [▶ ❷] button to select .
3. Press the [▲ AF] / [▼ ❸ ❹] button to select [Date & Time] and press the  button to enter the menu.
4. Press the [◀ ❶] / [▶ ❷] button to select the Date / Time to be adjusted: Time is displayed in YYYY.MM.DD / HH:MM.
5. Press the [▲ AF] / [▼ ❸ ❹] button to press the value for your selected entry. After you finish your settings, press the  button to confirm.
6. Press the  button and the shooting screen will appear.

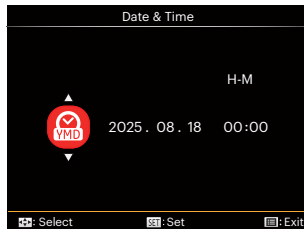
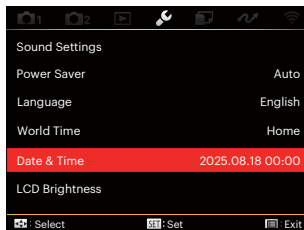

MODE OVERVIEW

LCD Display

Overview of the Screen Icons in Shooting Mode

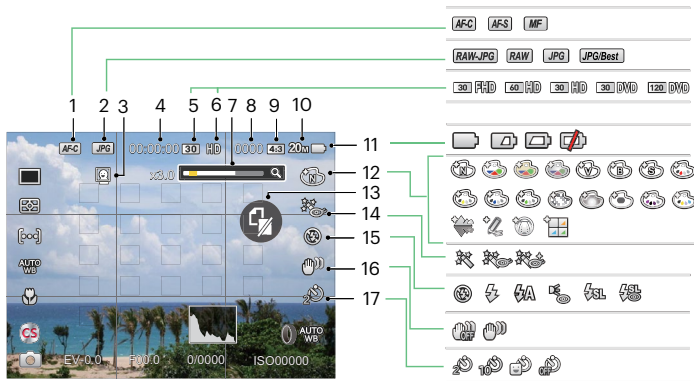

1	Focus Mode	7	Zoom Display (By turning the Zoom Lever)	13	No Memory Card
2	Quality	8	Number of Pictures in Static Mode	14	Beautifier
3	Face Detection	9	Ratio of Shooting Pixels	15	Flash Mode
4	Maximum Record Time	10	Image Size	16	OIS
5	Recording Speed (fps)	11	Battery Status	17	Self-Timer
6	Video Pixels	12	Color Effect		

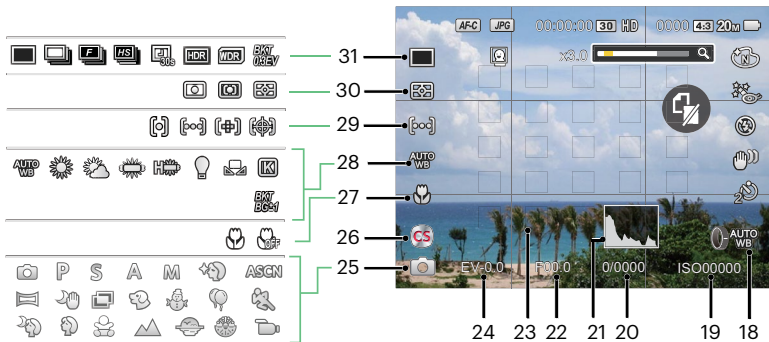

18	Lens Function Ring Custom Settings	23	Focus Frame	28	White Balance
		24	Exposure Compensation Value	29	AF Area
19	ISO Value			30	Expo Metering
20	Shutter Speed	25	Shooting Mode	31	Single / Continuous Shot / HDR / WDR / AE Bracketing
21	Histogram	26	Custom Settings		
22	Aperture Value	27	Macro Mode		

Overview of the Screen Icons in Movie Mode

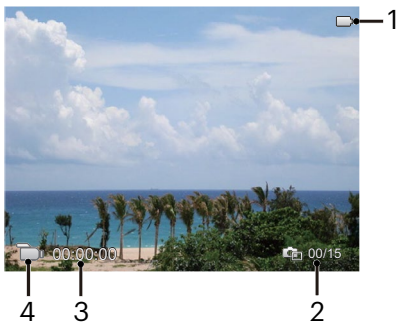

1	Battery Status
2	Number of Videos Captured
3	Continuous Recording Time
4	Movie Mode

Overview of the Screen Icons in Playback Mode



1	Quality	9	Zoom Magnification Area
2	Capture Date	10	Image Zoom Ratio
3	File Name	11	Index Prompt
4	Shooting Pixel Ratio	12	Touch-Up
5	Image Size	13	HDR
6	Battery Status	14	DPOF File Icon
7	Continuous Shot Group Playback	15	File Protection Icon
8	Image Area		

How to Take Photos

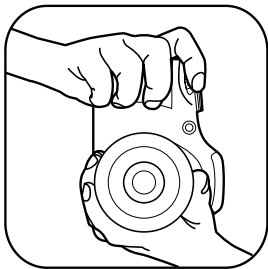
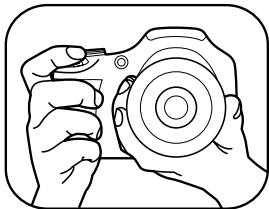



1. Hold the camera with both hands, being careful to not block the flash and lens with fingers.
2. Point the lens toward the subject you want to take a picture of, then frame it with the LCD.
3. Use the Zoom button to select Tele or Wide positions to zoom in or out on your subject.
4. Press the shutter button halfway down to focus on the subject. When the focus frame turns green, press the shutter button down completely to take the picture.

Using the Mode Dial







This camera provides a convenient Mode dial that allows you to manually switch between different modes with ease. The available modes are listed below:

Mode Name	Icon	Description
Auto Mode		In this mode, the optimal conditions for taking pictures will be set based on the subject and environment. It is the most commonly used mode for taking pictures.
Program AE	P	Under different scenes, the user can switch the ISO and EV value according to personal preference, the camera can automatically set the shutter speed and aperture value.
Shutter Priority	S	Setting allows you to adjust the shutter speed / EV value and ISO value. The camera automatically sets the aperture value based on the shutter speed and ISO value to get the most appropriate exposure value.
Aperture Priority	A	In this mode, you can adjust the aperture size, EV and ISO values. The large aperture is to highlight the object focused through blurring the background, while the small aperture is for clear focus on both the background and the object.

Manual Mode	M	This mode is for manually setting the aperture, shutter speed and ISO value.
Face Beautifier		This mode automatically enhances facial features with skin softening touches and eye brightening capabilities.
Wireless® Mode		Enable image transmission and remote control by connecting smart device with Wireless®.
Scene Mode	SCN	Choose from 14 different pre-set scene types and effects for your photos.
Movie Mode		Record videos.
Custom Settings	CS	The user can store frequently used shooting modes and parameters. Switching to this mode enables quick adjustment.

Please refer to the table below if any nonadjustable options in **PSAM** mode:
(O: Available X: Not available)













Options Mode	Aperture	Shutter	EV	ISO
P	X	X	O	O
S	X	O	O	O
A	O	X	O	O
M	O	O	X	O

1. Turn the mode dial to select the **PSAM** mode you want.
2. Press the  button to configure settings.
3. Press the [] / [] button to select an adjustment setting.
4. Press the [ **AF**] / [] button to adjust the parameters.
5. Press the  button to confirm the settings and enter the shooting screen.





Please note that even if an option is not able to be adjusted in a particular mode, its value will still be displayed on the shooting screen.

Face Beautifier +

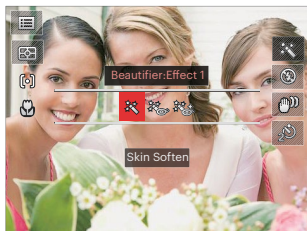
1. Turn the Mode dial to select Face Beautifier Mode ().
2. Press the  button and press the [ AF] / [  ] button to select .
3. Press the [ ] / [ ] button or turn the  jog dial to select an option and press the  button to confirm and enter the shooting screen.



-  Effect 1: Skin Soften
-  Effect 2: Skin Soften + Eye Brightening
-  Effect 3: Skin Soften + Eye Brightening + Eye Enlargement

Wireless® Mode



Enable image transmission and remote control by connecting smart device with Wireless® communication.

Before utilizing Wireless® Mode, please review the following:

- Your smart device operating system version needs to be iOS 16 or higher, or ANDROID 12.0 or higher. If not, please upgrade your smart device before using the APP.
- Please do not use in places that have a high intensity magnetic fields, electrostatic and electric wave interference (for example near a microwave oven), which may cause failure in receiving signals.
- To maintain a connection, please keep the camera within 10 meters (32.8 feet) without signal shielding interference.
- Please do not use Wireless® connection functionality on a plane.
- The camera and the smart device can only be connected one to one.

Downloading the APP package:

Download a dedicated installation package from the application store (APP name: PIXPRO Remote Viewer ) and then install it.

- ANDROID™ devices : Search and download the APP “PIXPRO Remote Viewer”  in Google play, and install it following the instructions on the interface.
- iOS™ devices : Search and download the APP “PIXPRO Remote Viewer”  in APP store, and install it following the instructions on the interface.

Rotate the mode dial to  and then enter the Wireless® selection interface.

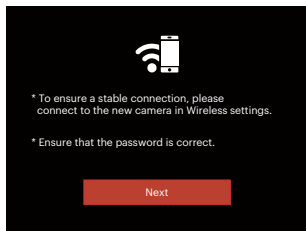





- Next: Enter the SSID interface.



Rotate the mode dial to disconnect.

Settings of Camera:

Press the [ AF] / [  ] button to select options to be adjusted, and press the  button to enter the option setting interface.

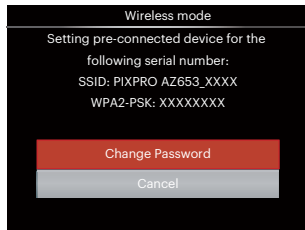

- Change Password: Enter the WPA2 PSK password refresh interface.
 - Yes: Create a new WPA2 PSK password.
 - No: Back to previous page.
- Cancel: Back to previous page.

Settings of Smart Device:

1. Enable the Wireless® feature of your smart device and search surrounding devices.
2. Select the name of camera SSID to be connected and then input the eight-digit number password after WPA2-PSK on the camera.
3. Click the icon of the PIXPRO Remote Viewer APP  to enable the APP.

Set up completion:

Once the APP is connected to the camera, functional operation can be enabled on the connected smart device.



Every AZ653 camera is shipped with a default factory Wireless® password that is randomized and unique to that camera and will not change unless you wish to reset the password with a new randomly generated password. If you wish to change the Wireless® password in your AZ653 from the assigned, unique factory password, you can do so by selecting and using the Change Password setting. If “Yes” is selected, a new random password will be generated and saved in the camera until changed or if you use the “Reset” function. If you reset your AZ653 to the factory settings, then the initial, randomly factory assigned and unique Wireless® password will be restored to your camera. (Please refer to Reset instructions on page 107).

Display of Wireless® Connection Status:

The Wireless® has successfully connected but APP is not enabled.

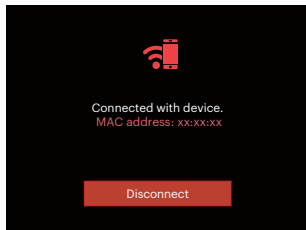

The Wireless® has successfully connected and APP is enabled.

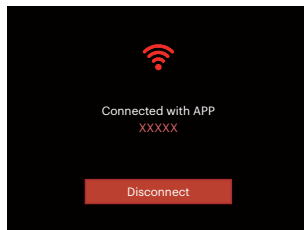

To disconnect from Wireless®:



- No: Keep Wireless® connected and back to previous page.
- Yes: Disconnect and back to Wireless® connection screen.



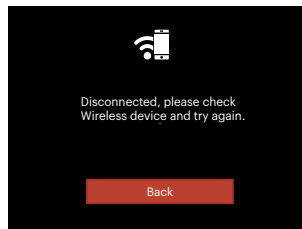







Disconnected from smart device
Wireless®:





- Back: Back to the SSID interface.

Setting

The name of this camera can be changed under Wireless® settings.

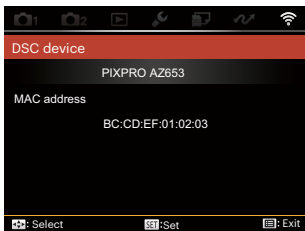
1. In other modes, press the  button, press the [**▲AF**] / [**▼**  ] button to select .
2. Press the  button to enter the menu.
3. Press the [**◀** ] / [**▶** ] button to select .
4. Press the [**▲AF**] / [**▼**  ] button to select the item to be set and press the  button to enter the menu.







5. Press the  button to confirm settings and then skip the menu.

DSC Device

The default name of DSC device is [PIXPRO AZ653]. Change the name of DSC device through typing.



Meanings of Interface Icons:

Icon	Description
	Delete the last letter
	Switch the display of letters in capital and lowercase
	Move the Cursor
	Switch the symbol input
	Input Space

MAC address

Check the wireless MAC address of this camera.

App Operating Instructions

Refer to the "PIXPRO Remote Viewer User Manual" located on the web:

Americas / Europe



[http://kodakpixpro.com/Americas/ support/downloads.php](http://kodakpixpro.com/Americas/support/downloads.php)







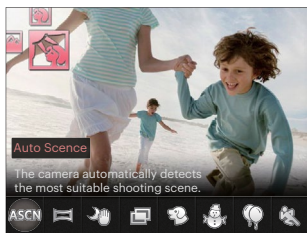







Scene Mode SCN

You can select an appropriate mode from the 14 scene modes according to the type of environment you are shooting in. The camera then automatically configures the most appropriate settings for the best possible photos.

1. Rotate the Mode dial to **SCN**, then the LCD will display as below:









2. Press the [◀🌸]/[▶⚡] button to select a scene, and press the (SET) button to confirm.
3. If any need of changing the scene, please press the (MENU) button and then the (SET) button and finally the [◀🌸]/[▶⚡] button to reselect the scene.

Scene		Description
 ASCN	Auto Scene	The camera automatically detects the type of scene.
	Panorama Mode	For shooting up to 360-degrees of landscape.
	Handheld Night	Reduce blur when shooting low light / illuminated scenes.
	Multi Exposure	Take several shots and overlap as a single image.
	Cat / Dog	The camera automatically takes a picture when a dog or cat face is detected.
	Snow	For subjects in the snow. Reduce underexposure.
	Party	For subjects at night without using a tripod. Capture sharp shots without blur.
	Sport	For fast-moving subjects. Capture sharp action shots without blur.
	Night Portrait	For portraits against night time scenery.
	Portrait	Most suitable for capturing people, focusing on their face.
	Children	For kids and pets. Flash is disabled for eye protection.
	Landscape	Speed adjusted for brilliant images.
	Sunset	For sunsets. Capture subjects in strong sunlight.
	Fireworks	For fireworks at night. Slow shutter speed adjusted for brilliant images. The use of a tripod is recommended with this setting.

Auto Scene (ASCN)

In “ASCN” scene mode, the camera can intelligently detect different environments and automatically select the best scene and photo settings for you.













“ASCN” can intelligently detect the following scenes:

Mode Name	Description
 Auto	The camera automatically adjusts the exposure and focus to ensure the best possible pictures.
 Landscape	For landscapes, automatically adjusts the exposure to match the background.
 Backlit Portrait	When the sun or any other light source is behind you, automatically adjusts the foreground exposure to produce the best pictures possible.
 Macro	The Macro setting is ideal for shooting small objects or close-up photos.
 Night Landscape	For night scenes, automatically increases the ISO value to compensate for low light.
 Portrait	Most suitable for capturing people with focus on their faces.
 Night Portrait	When you take portraits at night or in low light conditions, automatically adjusts the exposure for people and night scenes.



Panorama Mode

This feature allows you to capture a panoramic view that will have significantly more content than a single photograph. Follow the arrow while keeping the camera steady to seamlessly shoot an ultra-wide scene of up to 360 degrees.

Follow the steps below:

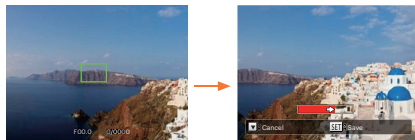
1. Select the Panorama Mode () and then press the  button to confirm.
2. Press the [ **AF**]/[  ]/[  ]/[ ] button to select a shooting direction. (Should you not select a direction, the default shooting direction is “right”.) 2 seconds later, the camera will be ready to take pictures. You can also press the  button or press the shutter button halfway down to be ready to take pictures.
3. Compose your shot on the LCD and half press the shutter button to focus on the subject. After focusing, fully press the shutter button down to take the first picture. At this time, the process dialog of panorama mode stitching appears on the screen.



4. Pan the camera according to the set direction. When the range of motion does not exceed the range that the camera can detect, the progress bar behind the arrow partially turns red. When it completely turns red, panorama mode shooting is finished.
-  Panoramic image can be played back by the method of flash playing. Please see the animation panoramic playback on page 75.
 -  In Panorama Mode, the Flash, Self-Timer, Macro Modes and Exposure Compensation are not available. Focus adjustment is also not available at this time.

 During panorama mode shooting, press the **(SET)** button to interrupt shooting and save the current pictures taken. Press the [▼ 🗑️ ⏸] button to cancel shooting and not to save the previously taken pictures.

 During panorama mode shooting, when the moving direction of the camera is wrong or the angle deviates from the internal settings, the LCD shows a warning message [Improper alignment. Please try again.] and the current pictures taken are saved.

Multi Exposure

Suitable for shooting moving objects (as many as 6) in the same background.

 Keep camera steady before shooting. Press and hold the shutter button to take 6 photos continuously when it will stop automatically. To stop shooting, release the shutter button in the midway.

 Objects shall be moved only from left to the right in order to be recorded. Objects moving from other directions would not be recorded.

 Shooting effect will be influenced if object is moving too fast or too close.

Cat / Dog

1. It defaults to enabling the auto shoot after entering the Cat / Dog mode. When a face of cat or dog is detected, the camera will take photos automatically. Meanwhile, you also may press down the shutter button to shoot.
 2. Press the [▼ 🗑️ ⏸] button to enter Auto Shoot menu. If this function is disabled, you may only take photos manually.
-  At most, 10 cat /dog faces can be detected at one time.

Functions that can be adjusted in each scene are as below:

Scene	Adjustable Functions
Auto Scene	Flash*1 / Self-Timer
Panorama Mode	None
Handheld Night	Expo Metering / Self-Timer*2
Multi Exposure	Expo Metering
Cat/Dog	Auto Shooting / Continuous Shot / Expo Metering / Macro
Snow	Continuous Shot / Expo Metering / Flash/Self-Timer
Party	Continuous Shot / HDR/Expo Metering / Flash / Self-Timer / Macro
Sport	Continuous Shot / Expo Metering
Night Portrait	HDR / Expo Metering / Self-Timer
Portrait	Continuous Shot / HDR / Expo Metering / Flash / Self-Timer / Macro
Children	Continuous Shot / Expo Metering
Landscape	Expo Metering / Self-Timer*2
Sunset	HDR / WDR / Expo Metering / Flash / Self-Timer*2
Fireworks	Continuous Shot / Expo Metering / Self-Timer*2

*1 Means the flash as an option of Night Landscape mode in Auto Scene is non-adjustable.

*2 Means Self-Timer smile is not included in the Self-Timer.

For continuous shot, there are only [Continuous Shot] and [Time-Lapse] for selection.

Custom Settings (CS)

The user can store frequently used shooting modes; and parameters and switch to this mode for a quick adjustment. Settings under **CS** mode (unset state or state after reset):

1. Turn the Mode dial to select the **CS** mode, and enter the setup screen, as shown in the figure below:



2. As shown in the figure above, press the [◀📷] / [▶📷] button to select a capture mode that you want to define as **CS**, and press the (SET) button to enter the shooting screen.
3. As shown in the figure, press the (M) button, and choose whether to continue the **CS** mode setting or rotate the Mode dial to skip.

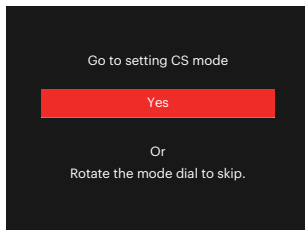

For setting under other modes (use this method to select a different custom setting):

1. Select any mode to be stored.
2. Set your desired parameters in the current mode.
3. Press the (M) button, press the [▲AF] / [▼🗑️🔄] button to select [☰], and press the (SET) button to enter the menu.
4. Press the [◀📷] / [▶📷] button to select 📷2.

5. Press the [▼🗑️🔄] button select [Custom Settings] and press the (SET) button to enter the menu.

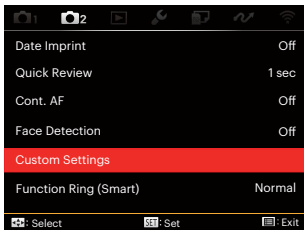

6. Select [Yes] to save or [No] to cancel.

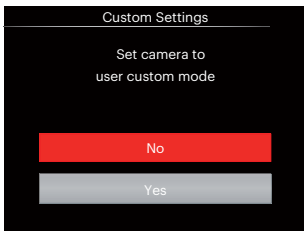

7. Turn the mode dial to switch to the custom settings (**CS**).
8. The photo settings you stored the last time are used.



When the **CS** mode is used for the first time, there is no preset parameter stored in the **CS** mode.



If you want to remove the parameter setting of [Custom Settings], please see the reset function on page 107 to operate.

BASIC OPERATION

Using EVF (Electronic View Finder)



EVF functions as the LCD, which can be used to observe the scene and objects and for playback, preview and menu operations.

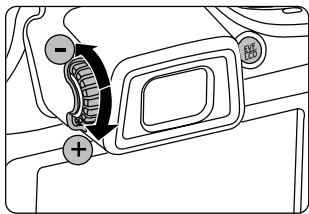

EVF has the following advantages:

It will not be affected by ambient light and may avoid poor composition due to light reflection on the LCD.



Follow the steps below:

1. Turn the camera on and press the  button to switch to the EVF display. At this time, the LCD will become black.
2. View the scenes and objects through the EVF.
3. When the screen display is not clear, rotate the diopter adjustment knob to adjust the screen sharpness.
4. Press the  button again or restart the camera to switch back to the LCD display.

-  The bending of light that takes place in a lens is referred to as refraction. The strength of refraction is measured in diopters.
-  Diopter adjustment is aimed to help nearsighted (-400 or less) or farsighted (+200) individuals see clearly through the viewfinder (EVF).

Using the Zoom Function

Your camera is equipped with two types of zoom functions: Optical Zoom and Digital Zoom. Toggle the Zoom Lever of the camera to zoom in or out on the subject while taking pictures.

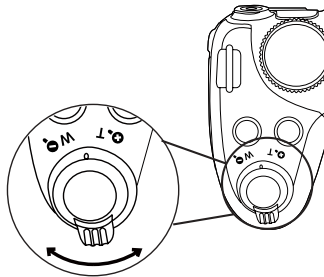

Zoom Lever

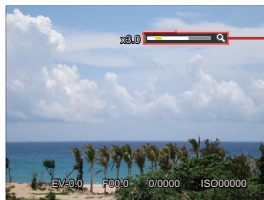

Zoom Indicator

When the Optical Zoom reaches the threshold as Digital Zoom, release and turn the Zoom lever to T to switch between the Optical Zoom and Digital Zoom.

Display Setting

Mode: **PSAM** **SCN** **CS**

Press the **DISP** button to switch among 4 screens.

Function Message Display



No Message Display

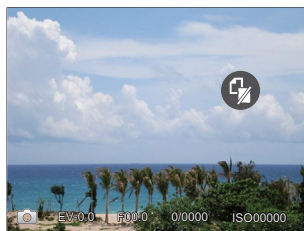



Display with Grid and Histogram

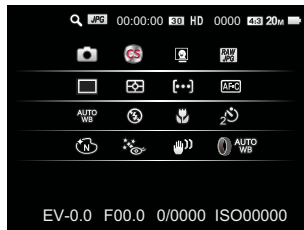

Message Display



Mode: 

Press the  button to display the playback screen, press the  button to switch among 3 screens.

Function Message Display

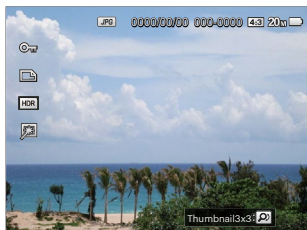

No Message Display



Detailed Message Display



AF Area

In different photo shooting modes, you can select different focus methods. (Adjustable in **PSAM** mode)

1. Press the [**▲ AF**] button to display the settings screen.

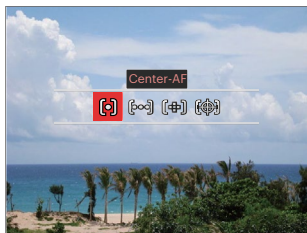

2. Press the [**◀**] / [**▶**] button to select the following 4 modes:

Center-AF
The focus frame appears on the center of the LCD to focus on the subject.

Multi-AF
The camera automatically focuses the subject in a wide area to find the focus point.

Spot Focus
Choose the single-point focus position within the scope of focus.

Object Tracking
Smart tracking of the object in motion under the focusing shooting.

3. Press the **(SET)** button to confirm the settings and enter the shooting screen.

After enabling spot focus, turn the jog dial to adjust the position of focus point in the screen.





Object Tracking cannot be enabled until the camera is focused. For tracking the focus, you need to keep the shutter semi-pressed.

Macro Mode

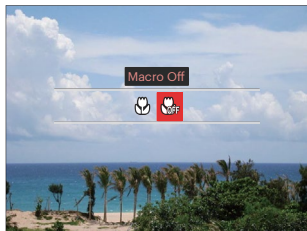
The Macro Setting is ideal for shooting small objects or close-up photos. This mode allows you to focus on subjects very close to the camera.

1. Press the [] button to enter the Macro Menu.



2. Press the [] / [] button to select the following 2 modes:
 -  Macro On
Select this option to focus on the object closer to the lens (At the W side, the shooting distance should be more than 1 cm).
 -  Macro Off
Select this option to disable Macro.
3. Press the  button to confirm the settings and enter the shooting screen.

Self-Timer Mode



Using this function to take pictures at pre-set intervals. The camera can be set to shoot after 2 seconds, 10 seconds after pressing the shutter or when a smile is detected.

1. Press the [▼🗑️👤] button to enter the Self-Timer menu.



2. Press the [◀️👤] / [▶️👤] button to select the following 4 modes:

-  Self-Timer 2 sec
A single picture is shot 2 seconds after the Shutter button is pressed.

-  Self-Timer 10 sec
A single picture is shot 10 seconds after the shutter button is pressed.
-  Self-Timer Smile
Press the shutter button and a picture will be taken immediately after a smile is detected.
-  Self-Timer Off
Disables the Self-Timer.

3. Press the (SET) button to confirm the settings and enter the shooting screen.

-  When enabling the Self-Timer, pressing the shutter or the [▼🗑️👤] button can disable the Self-Timer and return to the shooting screen while keeping the Self-Timer setting.

When enabling the Smile Detection, pressing the shutter or the **(SET)** button can disable the Self-Timer and return to the shooting screen while keeping the Self-Timer smile setting.

Self-Timer settings will remain after completion of shooting with the Self-Timer. They can be canceled by switching modes or by turning the camera off and then on again.





Flash Mode

The flash provides supplemental light for the scene. The flash is usually used when shooting against the light to highlight the object; it is also suitable for metering and shooting in darker scenes to improve the exposure.

1. Press the [**▶⚡**] button to enter the flash settings menu.



2. Press the [**◀🌸**] / [**▶⚡**] button to select the following 6 modes:
 - **(🌸)** Force Off
Flash is turned off.

-  **Fill Flash**
The flash goes off when a picture is taken, supplementing the existing light in a scene and helping to eliminate shadows.
-  **Flash Auto**
Camera flash goes off automatically based on existing light conditions.
-  **Red-Eye Reduction**
The camera emits a brief pre-flash before the picture is taken to reduce red-eye effects.
-  **Slow Sync.**
This allows you to take pictures of people at night that clearly show both your subjects and the night time backdrop. The use of a tripod is recommended when shooting with this setting.
-  **Slow Sync.+Red-Eye Reduction**
Use this mode for slow synchrony shots with red-eye reduction.

3. Press the  button to confirm the settings and enter the shooting screen.

 After pressing the shutter button half way to achieve focus lock, the flash will automatically pop up if needed.

WB (White Balance) Mode

The white balance function allows adjustment of the color temperature for different light sources. (Adjustable in **PS AM** Mode)

Follow the steps below to set white balance of the camera:



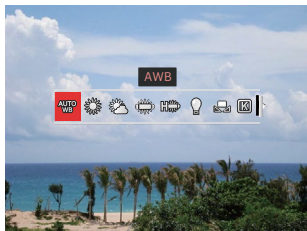

1. Press the **(SET)** button to enter white balance menu.



2. Press the [**◀**☀️]/[**▶**⚡] button to select the following 9 modes:

- **AUTO WB** AWB
 - ☀️ Daylight
 - ☁️ Cloudy
 - ⚡ Fluorescent
 - **H** Fluorescent H
 - 💡 Incandescent
 - 📄 Manual WB
Set WB according to the current light source, press the **(SET)** button to set.
 - **K** Color Temp. (1900K-10000K)
Press the **(SET)** button to enter and turn the **(◻)** jog dial to adjust the color temperature value.
 - **BKT WB** WB Bracketing
Press the shutter button once to take three photos with different WB settings.
3. Press the **(SET)** button to confirm the settings and enter the shooting screen.

WB Bracketing:

Press the **SET** button to enter options and then press the [**▲ AF**] / [**▼**  ] / [**◀** ] / [**▶** ] button to adjust the shift and turn the  jog dial to adjust the BKT value (0, 1 and 2).

Rotate clockwise to adjust X axis (B-A). BKT value

Rotate counterclockwise to adjust Y axis (G-M). BKT value

Press the **SET** button to confirm your settings.

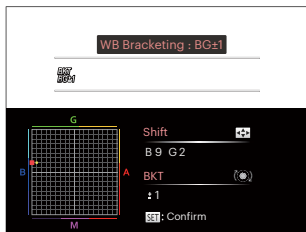

WB bracketing is for setting the bracketing range. Shift to both sides for 3 spaces at most. If at the page border, shift only to the other side and 2 photos can be taken. If no shift, only one photo can be taken.

Continuous Shot Mode

Functions that can be enabled under each mode may be different.

Mode:  **PSAM** +  **SCNCS**

For setting the single, continuous shot, Time-Lapse, HDR, WDR or AE bracketing functions.





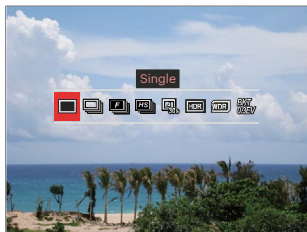

Please follow the following steps to set:

1. Press the  button to enter the continuous shot menu.



2. Press the [] / [] button to select the following 8 modes:

-  Single
Capture a single shot only.

-  Continuous Shot
For taking more than one picture continuously.
-  Cont. Shot-Fast (2M)
For continuous shot with 2M pixels.
-  Cont. Shot-High Speed (VGA)
For continuous shot with VGA pixel.
-  Time-Lapse
Take pictures based on the preset interval (30sec/ 1min/ 5min/ 10min). Press the  button to select the interval time.
-  HDR (-1EV, 0EV, +1EV)
This setting is to control the high dynamic image range in taking still pictures, with vivid effect in highlight and that the effect in dark parts can identify the outline and depth of the object. (Use of tripod is recommended)



- HDR effect may be affected by handshaking, light, subject movement or shooting environment.
- The flash is not available in HDR mode.
- It may take longer to save a photo in HDR.



WDR (Wide Dynamic Range)
When the camera detects that there is a big contrast in brightness between scenes and such scenes are against the light, it will automatically adjust the brightness and saturation to capture an image that better represents the scene.



- WDR is not available in mode.
- For WDR in the **SCN** mode:
 : adjustable;
 / : unadjustable and on by default;
Other modes: not available.



Please refer to page 123-124 for a detailed explanation of HDR and WDR effects.



AE Bracketing (0.3EV, 0.7EV, 1.0EV, 1.3EV, 1.7EV, 2.0EV)
The camera will automatically and continuously take three pictures separately with a brightness of original, darker and brighter as long as you press the shutter once. Press the button to select the range of exposure.

3. Press the button to confirm the settings and then enter shooting screen.

Mode:



Single











WDR



Exposure Compensation Functions Setting

The EV Function Menu of the camera includes functions, such as EV (Exposure Value) Adjustment, ISO, Shutter Adjustment, Aperture Adjustment, etc. Using the appropriate Function Settings can improve your pictures.

Please follow the steps below to set:

1. Press the  button to display the Settings screen.
4 options in [Exposure Compensation Functions Setting]:
 - EV Adjustment
 - ISO Adjustment
 - Shutter Speed Adjustment
 - Aperture Adjustment
2. Press the [ / ] button to select the Setting options.
3. Press the [ AF] / [  ] button to adjust the option values.
4. Press the  button to complete the setting and enter shooting screen.

EV Adjustment

Set up Exposure Compensation to adjust the picture brightness. If there is very high contrast between the photographed object and the background, the brightness of the picture can be adjusted as necessary. (This can be adjusted in **PSA**   Mode)

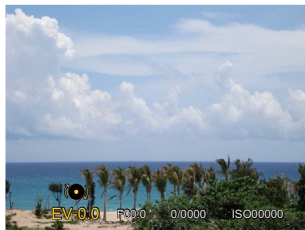

The adjustable range of exposure value is from EV -3.0 to EV +3.0.

ISO Adjustment

ISO allows you to set the sensitivity of the camera sensor. Please use a higher ISO value in darker places and a lower value in brighter conditions.

(This can be adjusted in **PSAM** + Mode)

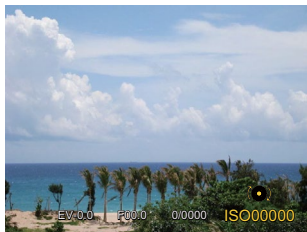

Options of ISO value: Auto (100-1600), 100, 200, 400, 800, 1600 and 3200.

Shutter Speed Adjustment

For shutter speed, the camera may automatically set the aperture value corresponding to the manually set shutter speed so as to obtain a most suitable exposure value. The movement of object may be shown by adjusting the shutter speed. High shutter value can help you more clearly capture fast moving objects, while low shutter value can better show the movement of objects. (This can be adjusted in **SM** Mode)

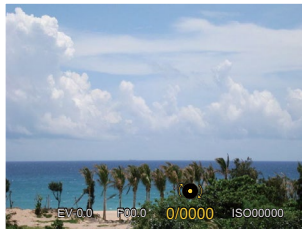

Aperture Adjustment

You can adjust the aperture size value. Selecting a large aperture opening will emphasize the point of focus and show a blurry background and foreground. A small aperture opening will keep both the background and main object in clear focus. (This can be adjusted in **AM** Mode)

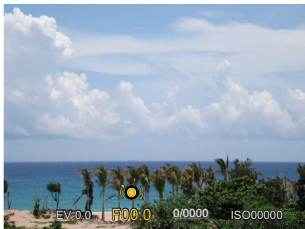

Using Quick Recording

In Photo Shooting Mode, press the  button to begin recording video.

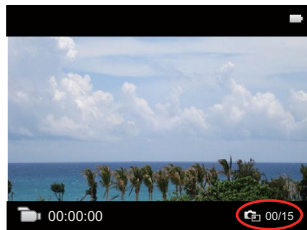

15 pictures at most can be taken by pressing the shutter when recording.

The sizes of images taken are as below when playing them back:

FHD -> 2M **2M**

HD -> 1M **1M**

DVD -> VGA **VGA**

Once you are finished, press the  button again to stop recording. The camera will save the video and return to the shooting screen.

"i" Button Function Menu





Functions that can be enabled are different under each mode.



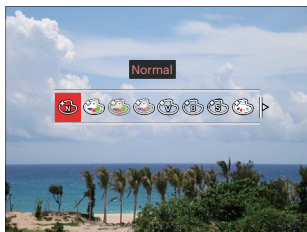

Mode: **PSAM** 

The image color setting allows you to select different effects.

1. Press the  button to select the Image color setting menu.



2. Press the [ ] / [ ] button to select the image color setting options.

-  Normal
-  EKTACHROME Film
-  KODACHROME Film
-  KODACOLOR Film

-  Vivid
-  Black and White
-  Sepia
-  Partial Color-Red
-  Partial Color-Yellow
-  Partial Color-Blue
-  Partial Color-Green
-  Dreamy
-  Vignetting
-  Salon
-  Punk
-  Negative
-  Reflection
-  Sketch
-  Fish Eye
-  4 Grids - Stylish(2M)

 Fish Eye effect is not available when shot size is 20M.

Using the Lens Function Ring

There is a lens function ring lever in one side of the lens. Moving it up and down can switch among ZOOM / AF, SMART and MF mode.

Zoom / AF Mode

Rotate the lens function ring for optical zoom.

1. Switch the lens function ring lever to position **ZOOM / AF**.

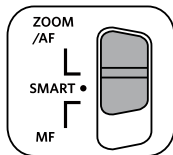

2. Rotate the lens function ring to optically zoom the object.

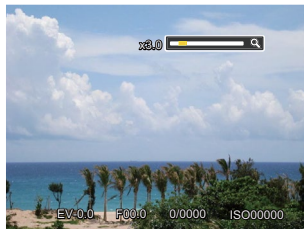



Rotating the lens function ring in Zoom / AF mode is only for optical zoom.

Function Ring (Smart) Mode

Rotate the lens function ring to set parameters of aperture, shutter, ISO, EV, etc.

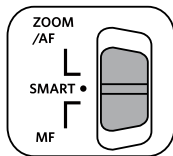
1. Switch the lens function ring lever to position **SMART**.



2. Rotate the lens function ring or turn the  jog dial to select options needed.

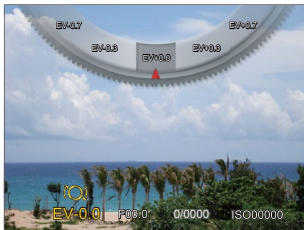

3. Press the  button to complete the setting and enter shooting screen.



The selection of functions of Function Ring (Smart) in the menu is needed before using Function Ring (Smart) mode. The default setting is Normal. (See P91 for details)



Options	Referred Pages
Normal	P64
Aperture Priority	P66
Shutter Priority	P65
EV	P64
ISO	P65
Continuous Shot	P62
Color	P67
White Balance	P60
Image Size	P82
Expo Metering	P79
Flash	P58
AF Area	P55

MF (Manual Focus) Mode

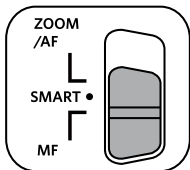

Rotate the lens function ring for manual focus.

1. Switch the lens function ring lever to position **MF**.



2. If the lens function ring is operated or the  jog dial is turned the focus enlargement frame will appear on the LCD. After clear focus is achieved through manual adjustment, press the  button to close the focus enlargement frame. The camera will return to the normal shooting screen. Semi-pressing the shutter button will have no effect; you need to fully press the shutter button to take a normal photo.







-  Manual focus works only under the **P S A M** mode.
-  The MF assist needs to be enabled in the menu before it will function. (See P85 for details)

PLAYBACK

Viewing Photos and Videos

For viewing taken photos and videos on the LCD:

1. After pressing the , the last photo or video clip taken will be displayed on the LCD.
2. Press the []/[] button to scroll through the photos or video clips stored in the built-in memory or on the Memory Card.
3. To play a selected video clip, press the  button to enter the movie playback mode.





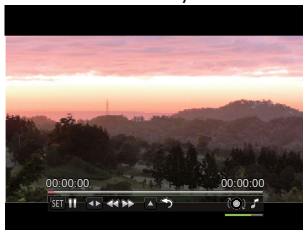

An operation guide appears on the screen when playing back a video. Press the appropriate buttons to enable the corresponding functions.

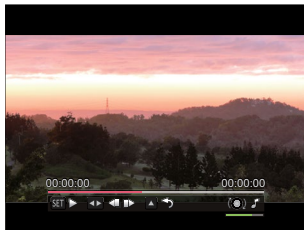



Under Playback











Paused



 	Pause
 	Rewind
 	Fast Forward

	Clockwise Volume Up
	Counterclockwise Volume Down
	Volume
	Mute

 	Play
 	Frame Backward
 	Frame Forward
 	Cancel Playback

Thumbnail View

When in Playback Mode, rotate the Zoom Lever counter to the **W** position to display thumbnail images of the photos and videos on the screen.

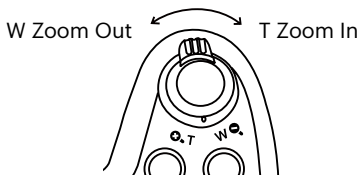

1. Slide the Zoom lever to switch between 3x3 and 4x4 thumbnails.







2. Press the [**▲ AF**] / [**▼**] / [**◀**] / [**▶**] button to select a picture or video clip to view and press the **SET** button to restore it to the original size.
3. As shown in the picture, press the button to select index mode.
4 options in [Index Mode] :
 - Single Index
 - Date Folder
 - Cont. Group
 - Slide Show

When the icon appears, it means this is a video file.





When the icon appears, it means this is a continuous group file.

Using Zoom Playback (for still pictures only)

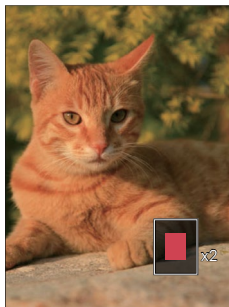
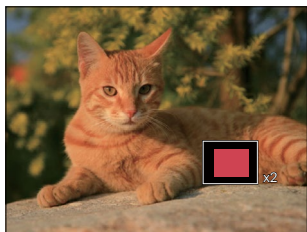
When playing back photos, you can also use the Zoom Lever to zoom in on the photos 2 to 8 times their original magnification.

1. Press the  button to switch to Playback Mode.
2. Press the [] / [] button to select a picture to be zoomed in on.
3. Rotate the Zoom lever to  position to zoom in.
4. Roll the  jog dial clockwise to zoom in and counterclockwise to zoom out.
5. The bottom right corner of the LCD will display the number of times the image is magnified and area of the photo shown.







6. Press the [] / [] / [] / [] button to navigate and select a portion of the photo to be zoomed in on.
7. Press the  button to return the image to its original scale.



Movie images cannot be magnified.

Continuous Shot Group Playback

High speed (VGA) and fast (2M) Continuous Shot images can be played back as a group.

1. Press the  button to enter Playback Screen.
2. Press the [] / [] button to select Continuous Group.
3. Press the  button to start playback.

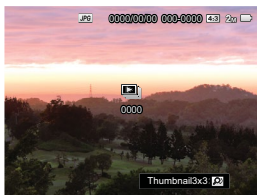



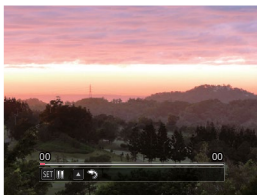

Cont. Group











Playing



Pause

 	Pause
 	Cancel Play (back to 1:1 playback for Continuous Group)





Playing

 	Play
 	Previous Photo (loop available only in Continuous Group)
 	Next Photo (loop available only in Continuous Group)
 	Cancel Play (back to 1:1 playback for Continuous Group)

Pause

Animation Panorama Play

Panoramic Animation Playing is to play full size image in accordance with the shooting direction. After playing, it will automatically return to the static screen of panoramic image.

1. Press the  button to enter Playback Screen.
2. Press the [] / [] button to select animated panoramic photos.
3. Press the  button to play in selected shooting direction.

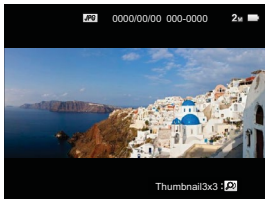





Video Panorama





Playing



Pause



 	Pause
 	Cancel Play

 In the process of panoramic animation playback, press the [ **AF**] button to stop playing and return to the playback screen.





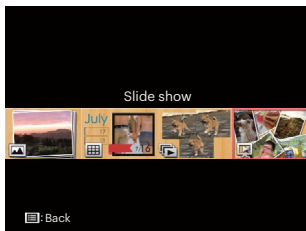

 Picture will not be rotated during panorama play or pause.

Slideshow





This setting allows you to view all the stored images as a slideshow.

1. Press the  button to enter playback screen.
2. Rotate the Zoom lever counter to the **w**  position to display thumbnails 3x3 and then press the  button to select the index mode.

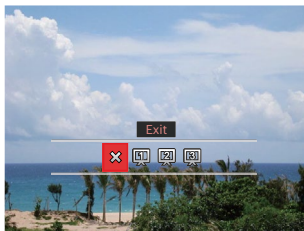

3. Press the [] / [] button to select Slideshow Playing and then press the  button to enter slide option.
4. Press the [] / [] button to select play effect and then press the  button to confirm.



-  Exit
-  Type 1: Slow-in and slow-out
-  Type 2: Separate in middle and move off to the left and right
-  Type 3: Separate into blocks and spin in

Deleting Photos and Videos

In Playback Mode, press the [▼🗑️🕒] button to delete your photos and videos.

To delete photos or videos:

1. Press the [⏪] button to switch to playback mode.
2. Press the [◀️🗑️] / [▶️🗑️] button to select the photos or videos to be deleted.
3. Press the [▼🗑️🕒] button and the deletion screen is displayed.

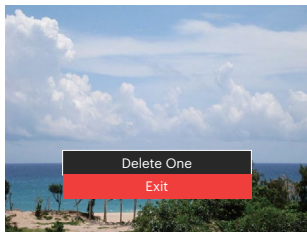

4. Press the [▲AF] / [▼🗑️🕒] button to select [Delete One] or [Exit] and press the [SET] button to confirm.



Erased photos / video clips cannot be recovered.



Please refer to page 98 for instructions on deleting more than one image at a time.

USING THE MENUS

Shooting Menu

Mode: PSAM SCNCS

1. In Shooting Mode, press the button to enter the Shooting Menu.

12 options in [Shooting Menu]:

- Continuous Shot Mode (refer to P62)
- Expo Metering
- AF (Auto Focus) Area (refer to P55)
- WB (White Balance) Mode (refer to P60)
- Macro Mode (refer to P56)
- Color (refer to P67)
- Flash mode (refer to P58)
- OIS (Optical Image Stabilization)
- Self-Timer Mode (refer to P57)
- Beautifier (Adjustable only in Mode)
- Select Scene (Adjustable only in **SCN** Mode)
- Menu

2. Press the [**AF**] / [] button to select the shooting menu to be set.
3. Press the [] / [] button or turn the jog dial to select options of the shooting menu to be set and then press the button to confirm.

Refer to the following pages for more details about each setting.





Functions that can be enabled are different under each mode.

Expo Metering

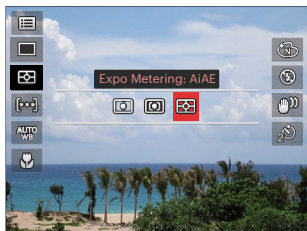
Use this setting to select the “target” size of the camera’s field of view to be metered.





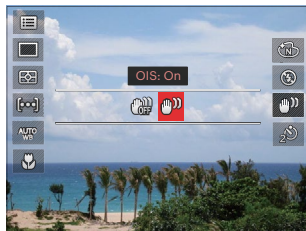

-  Spot
For metering the block displayed in the center of the screen.
-  Center
For metering the object in the center of the screen.
-  AiAE (Artificial Intelligence AE)
Evaluates the light intensity at multiple points in the frame and automatically determines the best value for the light meter.

OIS (Optical Image Stabilization)

This mode can help reduce photo blur caused by unintentional shaking, or low light.





-  OIS: Off
-  OIS: On
-  Use this image stabilization mode in dark environments.
-  Shooting in a windy or unstable environment (such as a moving vehicle) may cause blurry images.
-  You may not need OIS when using a tripod.

Beautifier

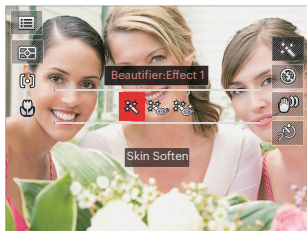
Select the effect for Face Beautifier Mode.



-  Effect 1: Skin Soften
-  Effect 2: Skin Soften + Eye Brightening
-  Effect 3: Skin Soften + Eye Brightening + Eye Enlargement





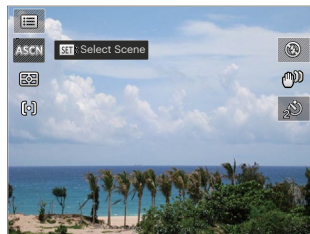

















Select Scene

Select a scene mode under SCN Mode.



Shoot Setting 1

Mode:  **PSAM** +  **SCNCS**  

1. Press the  button, press the [ **AF**] / [  ] button to select .
2. Press the  button to enter the menu.
3. Press the [ ] / [ ] button to select  1.
6 options in [Shoot Settings 1]:
 - Image Size
 - Movie Size
 - Quality
 - MF Assist
 - AF Assist Beam
 - Digital Zoom
4. Press the [ **AF**] / [  ] button to select the item to be set and press the  button to enter the menu.
5. Press the [ **AF**] / [  ] button to select an option and press the  button to confirm.

 Functions that can be enabled are different under each mode.

Image Size

The Size setting refers to the image resolution in pixels. A higher image resolution allows you to print that image in larger sizes without degrading the photo image quality.



- 20M: High quality printing
- 18M-3:2: full size printing
- 15M-16:9: 16:9 display
- 10M: poster printing
- 5M: A3 printing
- 3M: A4 printing
- 2M-16:9: 4"x 6" printing
- VGA: E-Mail



The larger the number of recorded pixels, the larger the file size and the fewer files that can be saved on your memory card.

Movie Size

Set the image resolution used during video recording.

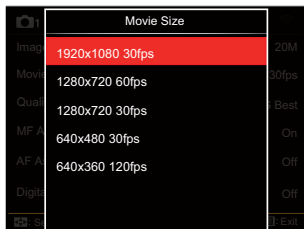

Total time of video recorded for each setting:

No.	Image Pixels	Frames (fps)	Recommendation	Recording Time (approximate) (4GB)
1	1920 x 1080 *	30	Class 10	30 Minutes
2	1280 x 720 *	60	Class 10	33 Minutes
3	1280 x 720 *	30	Class 10	59 Minutes
4	640 x 480	30	Class 10	106 Minutes
5	640 x 360	120	Class 10	54 Minutes

 * The longest recording time is 29 minutes at one time.

 When recording in higher pixel resolutions for extended periods of time, this can cause the camera to generate heat. This is not a camera malfunction.

 When the video format is set as 640 x 360 (120fps), shooting time is 30 seconds, playback time is 2 minutes.

 Sound recording is disabled when 640 x 360 (120fps) is chosen.

Quality

The Quality setting can be used to adjust the image compression ratio.



- RAW+JPG (Available in **PSAM** mode)
Creates two images: one in RAW and the other in JPG best.
- RAW (Available in **PSAM** mode)
The image file will contain more data that can be used for the purpose of editing on a computer.
- JPG Fine
- JPG Best

If RAW or RAW+JPG is selected, the settings of Colour Effect, Continuous Shot, Cont.Shot-Fast (2M), Cont.Shot-High Speed (VGA), HDR and AE Bracketing cannot be adjusted.



MF (Manual Focus) Assist

Enables an enlarged focus window during the use of manual focus to provide the user better visibility for focus control. (Adjustable in **PSAM** mode)

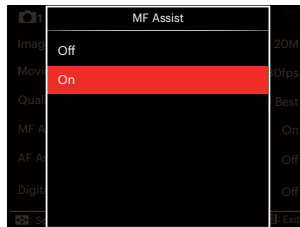

- Off
- On

AF Assist Beam

In a darker environment, the AF assist beam setting can be turned on for better focus.

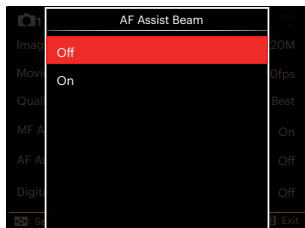

- Off
- On

Digital Zoom

This setting is for adjusting digital zoom. If this function is disabled, only optical zoom can be used.

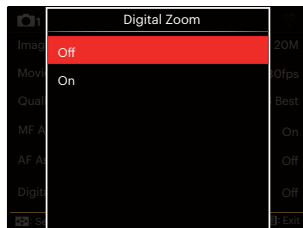

- Off
- On

Shoot Setting 2

Mode: PSAM + SCNC

1. Press the button, press the [AF] / [] button to select .
2. Press the button to enter the menu.
3. Press the [] / [] button to select 2.
6 options in [Shoot Settings 2]:
 - Date Imprint
 - Quick Review
 - Continuous AF
 - Face Detection
 - Custom Settings
 - Function Ring (Smart)
4. Press the [AF] / [] button to select the item to be set and press the button to enter the menu.
5. Press the [AF] / [] button to select an option and press the button to confirm.



Functions that can be enabled are different under each mode.

Date Imprint

Include a Date / Time stamp on the photo image.

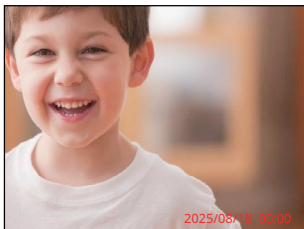
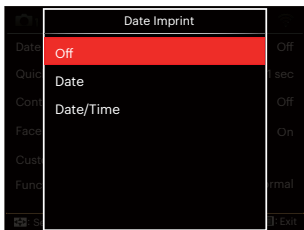

- Off
- Date
- Date / Time

Quick Review

This option enables a quick review of images immediately after capture. Each picture will be displayed on the LCD screen per the selections below.

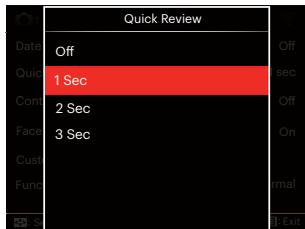

- Off
- 1 sec
- 2 sec
- 3 sec

Continuous AF

Use the Continuous AF setting to be able to continuously focus automatically when taking pictures.

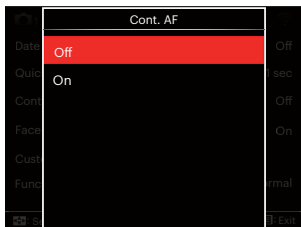

- Off
- On

Face Detection

Detects and focuses on faces to make all faces as clear as possible in Photo Mode.

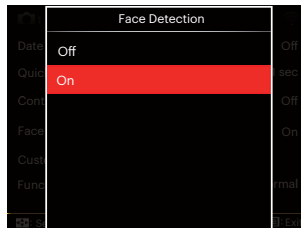

1. Hold the camera steadily and then focus on the object to detect its face. A focus frame will appear at the face on the screen when a face is detected.

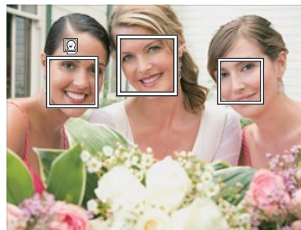

2. Press the shutter button half-way down to focus. The LCD will show a green focus frame when the subject is in focus.

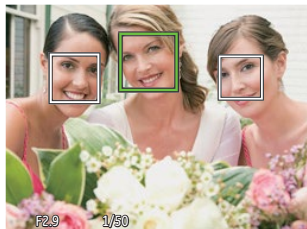

3. Press the shutter button all the way down to take pictures.



The closed eyes detection is usually on. If the camera detects in the course of quick review there is a face with eyes closed, a prompt of closed eyes will appear .

Custom Settings

Custom settings stores the current movie shooting mode and its parameters. The stored mode and parameters are automatically used in Custom Settings mode.

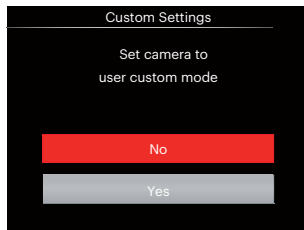

- No
- Yes

Function Ring (Smart)

The options listed below can be set as Function Ring (Smart) Custom. Once set, the chosen function can be quickly adjusted with the lens function ring during shooting.

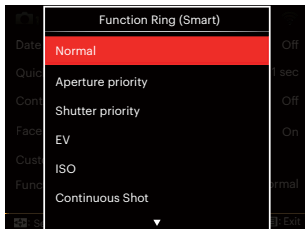



- Normal
- Aperture Priority
- Shutter Priority
- EV
- ISO

















- Continuous Shot
- Color
- White Balance
- Image Size
- Expo Metering
- Flash Mode
- AF Area

Playback Menu

Mode: 

1. Press the  button to display the playback screen and press the  button to enter the menu.







7 options in [Playback Menu]:

-  Menu
 -  Display Mode
 -  Rotate
 -  Color
 -  HDR
 -  Touch-Up
 -  Resize
2. Press the [ AF] / [  ] button to select the playback desired and press the  button to enter.
 3. Press the [ ] / [ ] button to select an option and press the  button to confirm.

Refer to the following pages for more details about each setting.

Menu 

7 options in [Menu]

- Shoot Settings 1  (See P81 for details)
- Shoot Settings 2  (See P87 for details)
- Playback Settings  (See P97 for details)
- General Settings  (See P101 for details)
- File Settings  (See P104 for details)
- Connection Settings  (See P108 for details)
- Wireless® Settings  (See P41 for details)

Display Mode

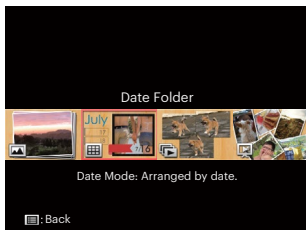



 Normal Mode: Display all images.

 Date Mode: Arranged by date.

 Cont. Photo Mode: Arranged by Cont. Photo Group.

 Slide Show

 The Date Folder is displayed in date order based on photo shooting date/time.

 If there is no continuous shot image file in memory, continuous photo mode cannot be enabled.

Rotate

You can use this setting to change the orientation of the picture.

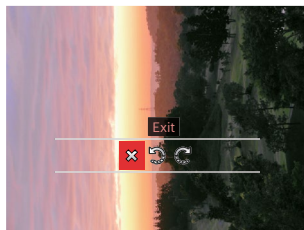

 : Exit

 : Turn Left

 : Turn Right

 Videos and panoramic pictures cannot be rotated.



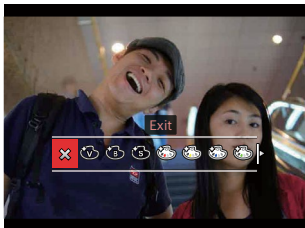

 The rotated picture file will replace the original photo.

Color

This setting allows you to change the picture color effect. The file is saved as a new photo and stored in memory together with the original photo.



-  Exit
-  Vivid
-  Black and White
-  Sepia
-  Partial Color-Red
-  Partial Color-Yellow
-  Partial Color-Blue
-  Partial Color-Green
-  Dreamy

-  Vignetting
-  Salon
-  Punk (4M)
-  Negative (8M)
-  Reflection
-  Fish Eye
-  4 Grids - Stylish (2M)

 In playing back single photos, press the **i** button to enter the color effect setting menu.

 Fish Eye effect is not available when shot size is 20M.

HDR HDR

With the HDR function, pictures that are overexposed may be corrected to optimize the highlights and lowlights captured to more accurately represent the actual scene.

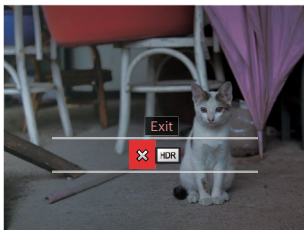

✕ : Exit

HDR : HDR

Select HDR with HDR :

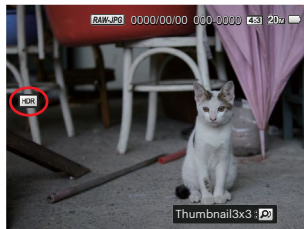

- After using the HDR function, the image will be saved as a new file and the original file is still stored in the memory.

Touch-Up

The playback beauty feature allows for beautification using three individual effects.

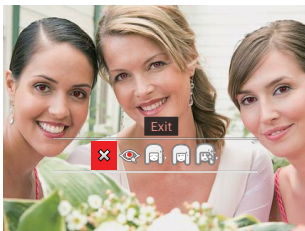



 : Exit

 : Red-Eye Reduction

 : Skin Soften

 : Eye Brightening

 : Eye Enlargement

 The Touch-Up referred to is the individual use of three effects. Beauty Mode allows you to select one, two, or all three of the effects combined.

Select  with touch-up:



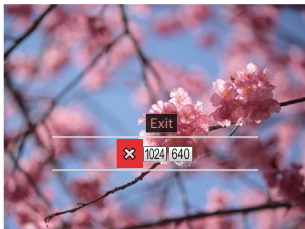

Resize

This setting allows you to resize a picture to a particular resolution and saves it as a new picture.



 : Exit

 : Resize to 1024x768

 : Resize to 640X480

 Only for adjusting pictures with high resolution to those with low resolution.

 Sizes of photos taken in panorama mode or rotated cannot be adjusted.











Playback Settings

Mode:  PSAM  SCNCS  

1. Press the  button, press the [ AF] / [  ] button to select .
2. Press the  button to enter the menu.
3. Press the [ ] / [ ] button to select .

5 options in [Playback Settings]:

- Protect
- Delete
- DPOF
- Trim
- Play Slide Show

4. Press the [ AF] / [  ] button to select the item to be set and press the  button to enter the menu.
5. Press the [ AF] / [  ] button to select an option and press the  button to confirm.

Refer to the following pages for more details about each setting.

Protect

To prevent any pictures or videos from being accidentally erased, use this setting to lock one or all of the files.

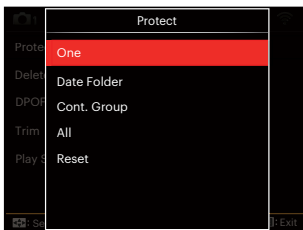



- One
Lock the selected photo or video if they are unprotected; unlock the selected photo or video if they are protected.
- Date Folder
Protect all photos in the Date Folder.
- Cont. Group
Protect all photos in the Cont. Group.
- All
Lock all photos or videos.
- Reset
Cancel all locked photos or videos.

Delete

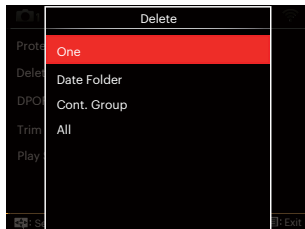
You can delete one or all photo/video files.



- One
Delete one photo or video.
- Date Folder
Delete all photos in the Date Folder.
- Cont. Group
Delete all photos in the Cont. Group.
- All
Delete all photos or videos.

 The “” indicator means a file is protected. File protection must be removed before a file can be deleted.

 Deleting files will cause DPOF settings to be reset.

 When one photo in the Cont. Group and Date Folders is protected, it will be kept but any other photos will be deleted.

 Deleted files will be permanently deleted and will not be able to be recovered or restored.

DPOF (Digital Print Order Format)

The DPOF feature allows you to compile and select a group of pictures that you would like to print and will save your selection on the memory card so that you can use the memory card to print without having to individually specify the photos you want to print.

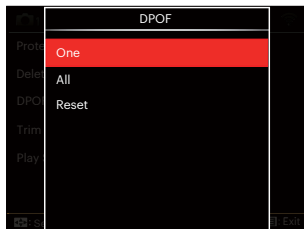

- One
- All
- Reset



 The printer that supports DPOF is needed for photo printing.

Trim

The Trim setting allows you to crop photos and save them as new pictures.

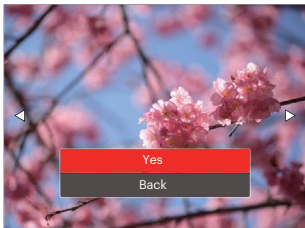
1. Select [Yes] to confirm trim. Toggle the zoom lever or turn the  jog dial to select the aspect ratio and press the [▲AF]/[▼🗑️🕒]/[◀🌿]/[▶⚡] buttons to adjust the part you want to trim.



2. Press the  button and the [Save change?] prompt appears. Select [] to change and save the picture. Select [] to cancel changes and return to the trim prompt screen.

 The image cannot be clipped/trimmed again once it has been clipped to 640X480.

 Videos, RAW files cannot be trimmed.

 A trimmed picture cannot be trimmed again.

Play Slide Show



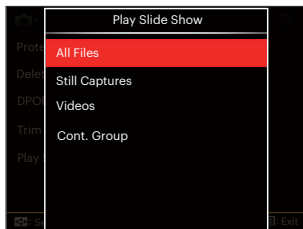



















This setting allows you to view all the stored images as a slideshow.



- All Files
To display and play back all images in memory card.
- Still Captures
To display and play back images of photo files in memory card.
- Videos
To play back movies on memory card.
- Cont. Group
To only play back images arranged by cont. group in memory card.

General Settings

Mode :  **PSAM** +  **SCNCS**  

1. Press the  button, press the [ **AF**] / [  ] button to select .
2. Press the  button to enter the menu.
3. Press the [ ] / [ ] button to select 
6 options in [General Settings] :
 - Sound Settings
 - Power Saver
 - Language
 - World Time
 - Date & Time
 - LCD Brightness
4. Press the [ **AF**] / [  ] button to select the item to be set and press the  button to enter the menu.
5. Press the [ **AF**] / [  ] button to select an option and press the  button to confirm.

Refer to the following pages for more details about each setting.

Sound Settings

With this setting you may adjust the sound volume.

Press the [◀🔊]/[▶🔊] button to adjust the volume and press the (SET) button to confirm.

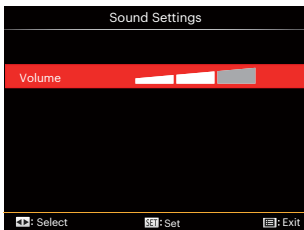

Power Saver

This setting allows you to save power and get the maximum possible running time for your camera's batteries. Turn the LCD and camera off automatically after a consecutive period of inactivity.

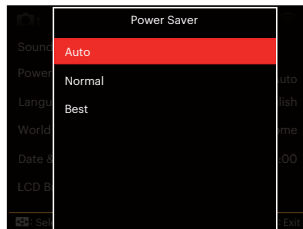

- Auto
- Normal
- Best

Power Saver	LCD power off time	Turn off time
Auto	3 min	5 min
Normal	1 min	3 min
Best	30 s	1 min

Language

Refer to the “Reset your language” section on page 25.

World Time

The World Time setting is a useful function for your overseas trips. This feature enables you to display the local time on the LCD while you are abroad.

1. Press the [▲ AF] / [▼ ☰ ☹] button to select the departure place (🏠) and destination (🌐) fields.
2. Press the [◀ 🌿] / [▶ ⚡] button to select a city located in the same time zone as that of the field. Press the (SET) button to confirm settings.



Date & Time

Refer to the “Reset Date / Time” section on page 26.

LCD Brightness







Use this setting to adjust the brightness of your LCD.

Press the [◀ 🌿] / [▶ ⚡] button to adjust the brightness of screen and press the (SET) button to confirm.



File Settings

Mode:  **PSAM**  **SCNCS**  

1. Press the  button, press the [▲AF] / [▼🗑️🕒] button to select .
2. Press the  button to enter the menu.
3. Press the [◀🌿] / [▶⚡] button to select .
5 options in [File Settings] :
 - Format
 - Copy to Card
 - File Numbering
 - Reset Settings
 - Version
4. Press the [▲AF] / [▼🗑️🕒] button to select the item to be set and press the  button to enter the menu.
5. Press the [▲AF] / [▼🗑️🕒] button to select [Yes] or [No] and press the  button to confirm.

Refer to the following pages for more details about each setting.

Format

Please note: formatting enables you to delete all contents on the memory card and camera's built-in memory, including protected photo and movie files.

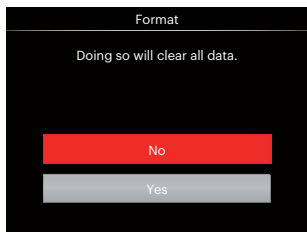

If you select [Yes] the camera will format its memory.



If there is no memory card in the camera, the built-in memory will be formatted; if there is a memory card, only the memory card will be formatted.

Copy to Card

Use this setting to copy the files stored in the built-in memory to a memory card.

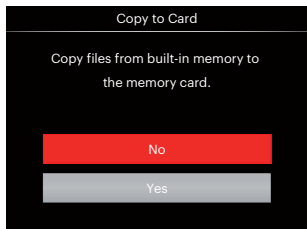

If there is no card available in the camera, this function will not be displayed.

File Numbering

After you take a picture or video clip, the camera will save it with a sequential number. You can use this to reset the file numbering to 1.

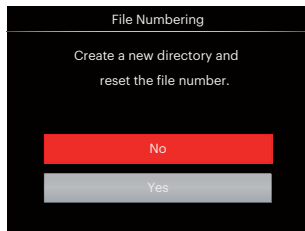

Reset Settings

Use this setting to restore the camera to its original default settings.

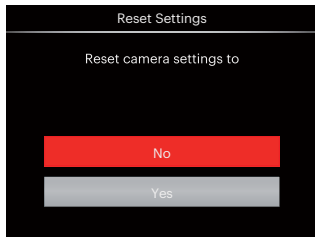

Version

Use this setting to view the current camera firmware version.

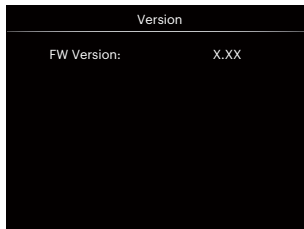

When there is a new firmware version in the memory card, select [Yes] to update.

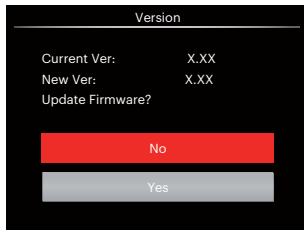

CONNECTION SETTINGS

Connecting to a Computer

You can use a USB cable to connect the camera and copy (transmit) photos to a computer or other device.

Setting the USB Mode

The camera's USB port can be used to connect to either a computer. The following steps will allow you to ensure that the camera is correctly configured to connect with a PC.

1. Press the  button, press the [▲ AF] / [▼ ⓧ] button to select  and press the  button to enter the menu.
2. Press the [◀ ⚡] / [▶ ⚡] button to select  and press the  button to confirm.

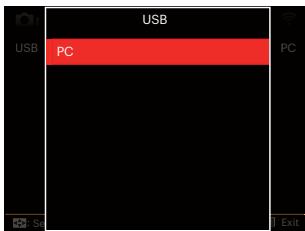

Transferring Files to your Computer

The computer will automatically detect the camera as a removable drive. Double-click the “My Computer” icon on the desktop to locate the removable drive and to copy folders and files in the drive to a directory on your PC as you would copy any typical folder or file.

Follow the steps below to connect the camera to a computer:

1. Make sure the computer is turned on.
2. Connect one end of the supplied USB cable to the USB port on your camera.
3. Connect the other end of the cable to an available USB port on your computer.
4. After the transmission is complete, disconnect the USB cable according to your computer manufacturer's instructions specifying how to safely remove USB devices.

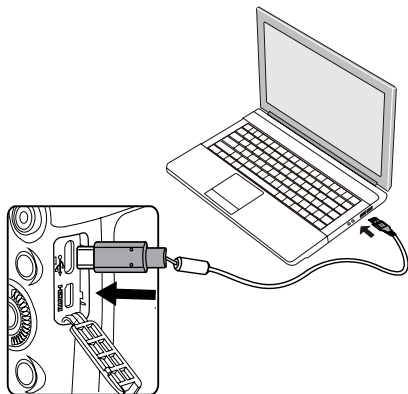

Supported HDMI Connections

HDMI (High Definition Multimedia Interface), is a fully digital audio/video transmission interface, through which uncompressed audio and video signals are transmitted.

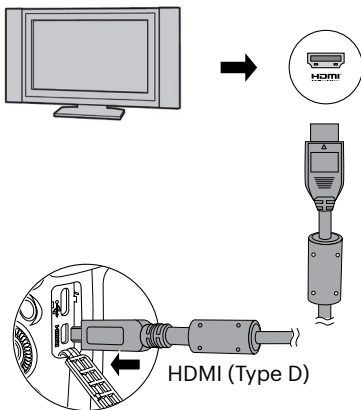

Connecting HDMI-Ready TV

1. Use the cable with high resolution output terminal (which should be purchased separately) to connect the camera to the television which meets HDMI standards.
 2. The camera will be automatically detected by the TV.
 3. After connecting via HDMI, the camera enters Playback Mode.
-  Make sure the camera and the TV are both turned on before connecting.

APPENDICES

Product Specifications



Design and specifications are subject to change without notice.

Image Sensor	Type	1/2.3" BSI CMOS
	Effective Pixels	20.68 Megapixels
	Total Pixels	21.14 Megapixels
Lens	Focal Length	4.3 mm (Wide) — 279.5 mm (Tele)
	35 mm Film Equivalent	24 mm (Wide) — 1560 mm (Tele)
	F number	F2.9 (Wide) — F6.7 (Tele)
	Lens Construction	14 groups 18 elements
	Optical Zoom	65x
	Focusing Range	Normal: (Wide) 50 cm ~ ∞ , (Tele) 250 cm ~ ∞ ; Macro: 1 cm ~ ∞ (Wide Only)
Autofocus System		TTL Autofocus
Electronic Viewfinder		Yes (-4 ~ +2 diopter)
Anti-Handshake		Optical Image Stabilization
Digital Zoom		4x Digital Zoom (Combined Zoom: 260x)

Number of Recording Pixels	Still Image	(4:3) 20MP: 5184 × 3888 10MP: 3648 × 2736 5MP: 2592 × 1944 3MP: 2048 × 1536 0.3MP: 640 × 480	(3:2) 18MP: 5184 × 3456	(16:9) 15MP: 5120 × 2880 2MP: 1920 × 1080
	Movie	1920 × 1080 (30fps), 1280 × 720 (60fps), 1280 × 720 (30fps), 640 × 480 (30fps), High-Speed Movie: 640 × 360 (120fps)		
Image Compression		Best, Fine		
DCF, DPOF (Ver1.1) Support		Yes		
File Format	Still Image	JPEG (Best, Fine), RAW, RAW+ JPEG (Best)		
	Movie	MOV [Image: H.264; Audio: Linear PCM (Stereo)]		
Shooting Modes		Auto Mode, Program AE, Shutter Priority, Aperture Priority, Manual Mode, Face Beautifier, Wireless® Mode, Scene Mode, Movie Mode, Custom Settings		
Scene Mode		Auto Scene, Panorama Mode, Handheld Night, Multi Exposure, Cat / Dog, Snow, Party, Sport, Night Portrait, Portrait, Children, Landscape, Sunset, Fireworks		
Detection Features		Face, Smile, Blink, Cat, Dog		
Photo Touch-Up		Red-Eye Reduction, Skin Soften, Eye Brightening, Eye Enlargement		

HDR	Yes
Scan Panorama	Up to 360°
LCD Display	3.0 inch (460k Pixels)
Image Auto Rotation	Yes
ISO Sensitivity	Auto (100-1600), ISO100 / 200 / 400 / 800 / 1600 / 3200
Focus Mode	Single AF, Continuous AF, Object Tracking, Manual Focus
Focusing Area Selection	Single Area Focusing, 25-Area-Focusing, Face Detection, Manual Area Focusing
Exposure Metering Method	Artificial Intelligence AE (AiAE), Center-Weighted Average, Spot (Fixed to Center of Frame), Face AE
Exposure Control Method	Program AE (AE-Lock Available), Shutter Prior AE, Aperture Prior AE
Exposure Compensation	± 3 EV in 1 / 3 Step Increments
Shutter Speed	1 / 2000 ~ 30 Seconds
Continuous Shooting	Yes
Playback Modes	Single, Index (9 / 16 Thumbnails), Slide Show, Date, Burst Shooting, Zoom (Approx. x2 ~ x8)

White Balance Control		AWB, Daylight, Cloudy, Fluorescent, Fluorescent H, Incandescent, Manual WB, Color Temp. (1900K ~ 10000K)
Flash	Flash Method	Pop-up (Auto)
	Flash Modes	Force Off, Fill Flash, Flash Auto, Red-Eye Reduction, Slow Sync., Slow Sync. + Red-Eye Reduction
Recording Media		Internal Memory: Approx. 15MB
		SD / SDHC / SDXC Card (Up to 1.5TB Support) [MMC Card Not Supported]
Multi-Language Support		27 Languages
Jacks		USB 2.0 (Type-C), HDMI (Type D)
Wireless®		Yes
Remote Control		Yes (via iOS / ANDROID smart device)
Power		Rechargeable Li-ion Battery LB-070, 7.4V 1020mAh, In-Camera Charging
Shooting Capability (Battery Performance)		Approx. 400 Shots (Based on CIPA Standards) Approx. 1h 30min for Video (@1080p/30fps)
Operation Environment		Temperature: 0 ~ 40°C, Humidity: 0 ~ 90%
Dimensions (W × H × D)		Approx. 126.0 × 89.0 × 111.4 mm (Based on CIPA Standards)
Weight		Approx. 588g (Body only)

Prompts and Warning Messages

Message	Description	Action
Warning! Battery exhausted.	Camera battery is depleted. It is a warning indicating the camera is going to shut off.	Charge battery or replace with a charged battery.
Built-in memory error!	An error has occurred in the built-in memory.	Try shutting the camera off and turning it on again.
Warning! Do not turn off your camera during update!	The message appears during the firmware update process.	The message disappears after the camera update and restart.
Battery temperature is too high.	Battery has reached a temperature that is not ideal for operation.	The message will disappear after 2 seconds. Let the battery cool before attempting to use the camera again.
Please update firmware after the battery is fully charged!	The firmware cannot be updated when power is insufficient.	Charge the battery fully before reattempting to update firmware.

Message	Description	Action
Cannot change settings under this mode.	Appears during shooting mode if a function can not be set by rotating the function ring.	Choose a different mode in order to change settings.
Improper alignment. Please try again.	The offset is too big for panorama shooting.	Remove the message after 2 seconds and return to shooting.
Connection Failed!	Failure to connect to PC.	Remove cable, reinsert cable, and retry connection
In this capture ***** Still size limited to ** M	After choosing the image size in the Function Ring (Smart), this message may occur when the still size limit is reached.	Remove the message after 2 seconds and return to shooting.
Capture reached maximum limit	Press the shutter to capture images in recording a video. If the number of images captured exceeds 15, there will be a prompt if you press the shutter again.	The message will disappear in 2 seconds with no influence to video recording.

Message	Description	Action
Write Protect !	The memory card is locked.	Turn off camera and remove SD card. Slide tab on the side of card to unlock.
Card Full !	The memory of the SD card is full.	Either delete photos or videos to create room on the card, or replace with another card that has available memory.
Memory Full !	The camera's internal memory is full.	Erase files or insert a memory card that has available memory.
Exceeded maximum folder number.	The folder number in the card exceeds the maximum folder number (999).	Copy the data to your PC, and format the memory card.
Card Error !	The card cannot be recognized after being formatted.	Check that the SD card is compatible with the camera.
Card is not formatted.	An error has occurred with the memory card.	Format the memory card. This will erase all data on the card; be sure to copy the data from the card onto another device if you wish to keep it.

Message	Description	Action
Slow access	When a card lower than Class 10 is recording movie above HD, it may be accessed slowly and the recording will not be continued.	Replace SD card with a Class 4 or higher card.
Cannot write to SD card.	The camera cannot write to the SD card.	Turn off the camera. Remove and reinsert the SD card and turn the camera on to try again. Check if the SD card is in a locked position, or if the memory is full.
No Picture!	When the play button is pushed and there are no files on memory card or in camera.	The message will disappear after 2 seconds and return to previous screen.
No continuous group file.	When the camera switches from Playback Mode to Cont. Playback Mode, and there are no continuous group files, this message will be displayed.	The message will disappear after 2 seconds and return to Thumbnail 3x3 mode.
No Red-Eye Detected!	No red-eye is detected when selecting Red-Eye Removal in Playback Touch-up.	The message will disappear after 2 seconds and return to the touch-up menu.

Message	Description	Action
Too many pictures for fast processing.	During Playback by Date, the images exceed specifications so it is not possible to play by date.	The message will disappear after 2 seconds and return to Thumbnail 3x3 mode.
Unable to recognize files.	The format of the file viewed is not supported or the file is damaged and cannot be recognized properly.	This message will only disappear after the file is deleted.
Protected! Undeletable!	The file is protected and cannot be deleted.	Unlocked file under "Protect", and make sure SD card is unlocked.
This image cannot be edited.	The file format does not support editing or the edited file cannot be edited again.	The message will disappear after 2 seconds and return to the original image.
Cannot edit because no face detected!	A face cannot be detected in the image in the touch-up menu.	The message will disappear after 2 seconds and return to the touch-up menu.
Suggest using tripod.	When continuous exposure mode (Sunset, Multi Exposure, Fireworks, Night Portrait) is enabled, this prompt message is displayed when the photo shooting screen is displayed for the first time.	This message will disappear after 2 seconds.

Troubleshooting

Problem	Possible causes	Solution
Camera does not turn on	<ul style="list-style-type: none">■ The battery has been depleted.■ The battery is not inserted correctly.	<ul style="list-style-type: none">■ Replace the battery.■ Correctly reinstall the batteries.
Camera turns off suddenly during operation	<ul style="list-style-type: none">■ The batteries have been depleted.	<ul style="list-style-type: none">■ Replace the battery.■ Make sure the camera is actually shutting off and not entering Power Save Mode, where the LCD will turn off after the camera has been idle for a period of time.
The picture is blurry	<ul style="list-style-type: none">■ Camera shakes while taking a picture.	<ul style="list-style-type: none">■ Turn on OIS Feature.■ Please use tripod for high magnification (above 15X) optical zoom. If you are holding the camera, be sure to use both hands.
Images and video files cannot be saved	<ul style="list-style-type: none">■ The memory card is full.■ The memory card is locked.	<ul style="list-style-type: none">■ Use another memory card or delete unnecessary files.■ Unlock the memory card.

Problem	Possible Causes	Solution
Saving data to memory card is slow	<ul style="list-style-type: none"> ■ Using a memory card below Class 10 may result in slower recording times. 	<ul style="list-style-type: none"> ■ Use a memory card with write Class 10 or higher to improve performance.
Cannot write to the memory card	<ul style="list-style-type: none"> ■ The memory card has been locked. 	<ul style="list-style-type: none"> ■ Release the write lock of the memory card or replace with another card.
Too many movies to process	<ul style="list-style-type: none"> ■ The number of pictures or folders in the memory card exceed the specifications, so the playback of data folder can not be displayed. 	<ul style="list-style-type: none"> ■ Delete unwanted files.

When shooting with stacked filters attached, the corners of the photo may turn dark (vignetting effect) because the filter holder blocks light from reaching the camera image sensor; especially, at wide angle zoom control settings. Please take test shots and review the results when using stacked filters. (Filter size : Φ 52mm)

If you choose to change the factory assigned, random Wireless® password on your AZ653 camera, please be sure to update and enter the new randomly assigned password on your smart device. Some smart devices will automatically remember and save any previously entered Wireless® password. Be sure to clear the old password on your smart device manually before attempting to connect the AZ653's Wireless® to your device. (Depending upon your smart device make and model, operation may vary, so please refer to your smart device user manual and instructions.”

iOS™ Example

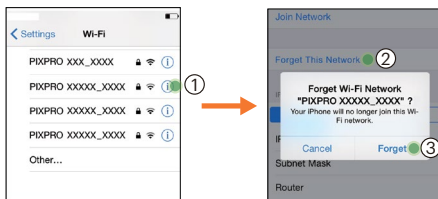

Android™ Example

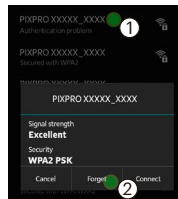

HDR- High Dynamic Range

HDR captures three photos taken at different exposure levels and combines them into one photo. This optimizes all the details of the object or scene in the photo. Even the features in darker areas can be viewed clearly. (The following pictures are an example of HDR composition.)

Underexposed



Normal exposure



Overexposed



HDR Mode



WDR- Wide Dynamic Range

For high light, intense sunlight, or environments with artificial light, WDR allows PIXPRO's smart algorithm to correct shadows surrounding a subject. This makes it easier to distinguish details in darker areas of the photo.

With WDR enabled video, clear images are provided when there are not only very bright areas, but also very dark areas in the camera's field of view. (The following pictures are an example of WDR.)



Without WDR



With WDR

Memory Card Compatibility

Refer to the chart below for compatible types of SD cards (✓ : Compatible X: Not Compatible)

	micro SD	micro SDHC	micro SDXC	Conversion adapter to SD card	SD	SDHC	SDXC
Format	FAT12, 16	FAT32	exFAT	-	FAT12, 16	FAT32	exFAT
Capacity	Up to 2GB	4-32GB	64GB-2TB	-	Up to 2GB	4-32GB	64GB-2TB
Compatibility	X	X	X	✓	✓	✓	✓

It indicates that the writing speed class will be displayed on the memory card. Use a memory card with the appropriate writing speed for the video recording mode to be recorded. (O: Recommended X: Not recommended)

	Speed Class	UHS Speed Class	Video Speed Class	Video Recording			
				4K	FHD	HD	VGA
90MB/sec			V90	O	O	O	O
60MB/sec		UHS-III	V60	O	O	O	O
30MB/sec		UHS-I	V30	O	O	O	O
10MB/sec	Class 10		V10	O	O	O	O
6MB/sec	Class 6		V6	X	X	X	X
4MB/sec	Class 4			X	X	X	X
2MB/sec	Class 2			X	X	X	X

Trademarks

- The terms HDMI, HDMI High-Definition Multimedia Interface, HDMI Trade dress and the HDMI Logos are trademarks or registered trademarks of HDMI Licensing Administrator, Inc.



- Microsoft and Windows are trademarks or registered trademarks of Microsoft Corporation in the United States and/or other countries.
- Macintosh, Mac OS, OS X and App Store are trademarks of Apple Inc., registered in the U.S. and other countries.
- SDXC logo is a trademark of SD-3C, LLC.
- USB Type-C™ and USB-C™ are trademarks of USB Implementers Forum.
- All other trademarks are the property of their respective owners.
- For the announcement of the UK PSTI, please refer to the website: <https://www.kodak.gtcie.com/en/content/13-uk-psti>

© 2025 JK Imaging Ltd. All Rights Reserved.

The Kodak and Kodachrome, Kodacolor and Ektachrome trademarks, logo and trade dress are used under license from Eastman Kodak Company.

All other logos, products or company names that are referred to in this document are trade names, trademarks or registered trademarks of their respective owners and holders. The owners and holders are not affiliated with JK Imaging Ltd., our products or our website.

JK Imaging Ltd., 14067 Stage Road, Santa Fe Springs, CA 90670 USA

kodakpixpro.com

Made in Myanmar (Burma)

Document No/Sequence: U.DIS.0084.0625.en.01



Ver. 1.0